



# Sakura International

Manufacturer & Exporter of Surgical Instruments

Muslim Colony, Sharif Park Haji, Sialkot 51310 Pakistan

 +92-300-6152628 Tel: +92-52-3259003

E-mail: sakura.pk12@gmail.com





**DIAGNOSTIC SET  
(ENT COMPLETE)  
01-001**

Consisting of Battery Handle (without Battery)  
3 Ear Specula, 1 Nasel Specula,  
2 Laryngeal mirrors with Holder  
1 Tongue Depressor Holder, 1 Bulb



**OTOSCOPE Set  
01-002**

Consisting of Battery Handle  
(without Battery) 3 Ear Specula, 1 Bulb

# DIAGNOSTICS

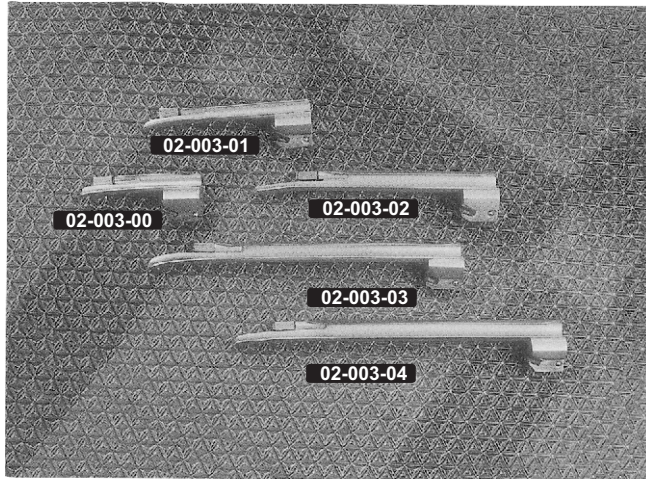

Miller



Miller  
02-003  
Laryngoscope  
set



McIntosh  
Laryngoscope Set  
03-006

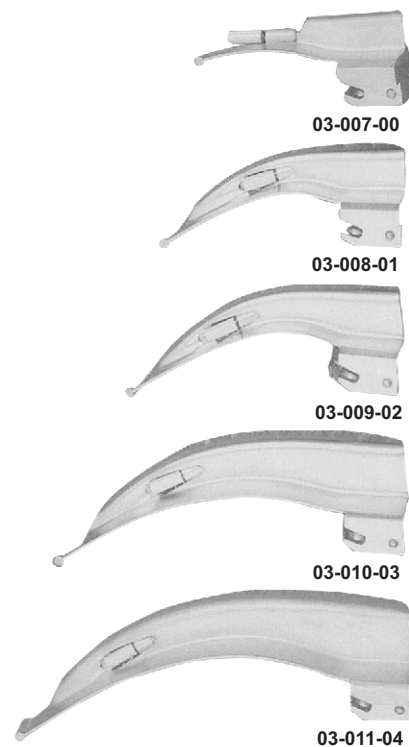

McIntosh

# Percussion Hammers & Aesthesiometers



**01-101**  
TROEMNER  
Size: 245 mm



**01-102**  
DEJERINE  
Size: 200 mm



**01-103**  
DEJERINE  
With Needle  
Size: 210 mm



**01-104**  
TAYLOR  
Size: 195 mm



**01-105**  
BERLINER  
Size: 200 mm

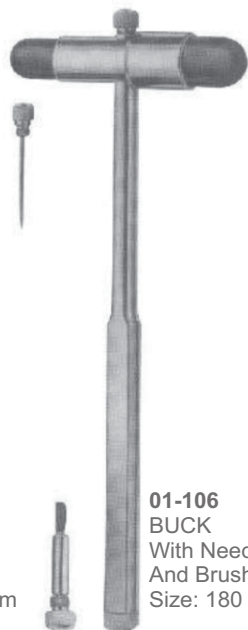

**01-106**  
BUCK  
With Needle  
And Brush  
Size: 180 mm



**01-107**  
RABINER  
With Needle  
And Brush  
Size: 255 mm



**01-108**  
ALY  
Size: 190 mm



**01-109**  
WARTENBERG  
Pinwheel For  
Neurological  
Examination  
Size: 185 mm

# Tongue Depressors



**01-144**  
SCHIMMELBUSCH  
Ether Mask



**01-145**  
HEISTER  
Mouth Gag  
Size: 130 mm



**01-146**  
FERGUSSON-ACKLAND  
Mouth Gag  
Size: 145 mm



**01-147**  
DENHARDT  
Mouth Gag With Silicon  
Inserts, Interchangeable  
Size: 125 mm



**01-148**  
ROSER KONIG  
Mouth Gag  
Size: 160 mm, 185 mm



**01-149**  
YOUNG  
Size: 165 mm

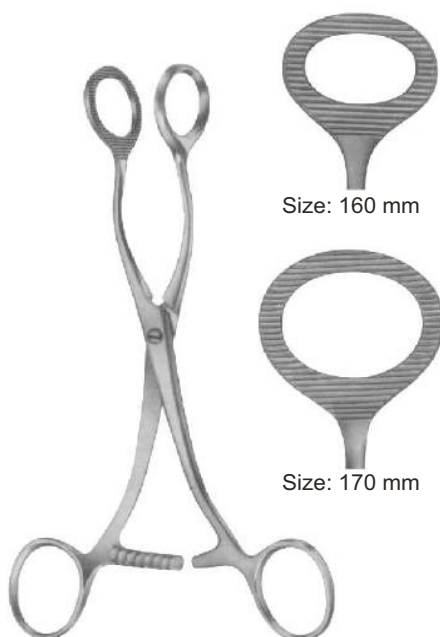

**01-150**  
COLLIN  
Size: 160 mm, 170 mm



**01-151**  
HEYWOOD-SMITH modif.  
Size: 215 mm

## Diagnostic Sets



**01-166**  
MILLER  
Laryngoscope Set, Consists Of Battery Handle ( Without Battery )  
With Four Miller Laryngoscope Blades

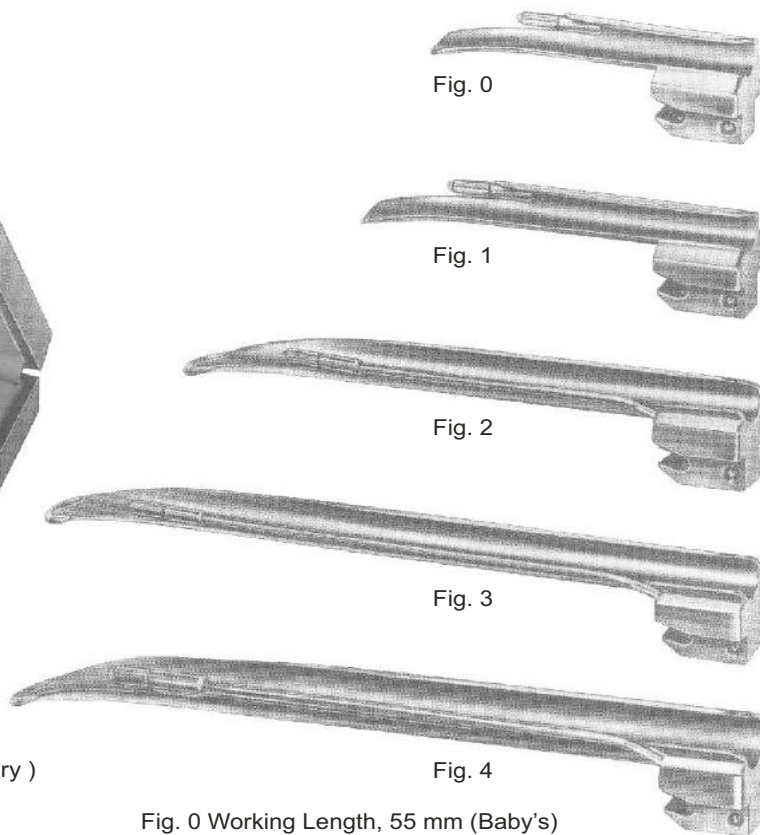

Fig. 0 Working Length, 55 mm (Baby's)  
Fig. 1 Working Length, 80 mm (Children's)  
Fig. 2 Working Length, 130 mm (Adolescent's)  
Fig. 3 Working Length, 170 mm (Women's)  
Fig. 4 Working Length, 180 mm (Men's)



**01-167**  
GUEDEL-NEGUS  
Laryngoscope Set, Consists Of Battery Handle ( Without Battery )  
With Four Miller Laryngoscope Blades

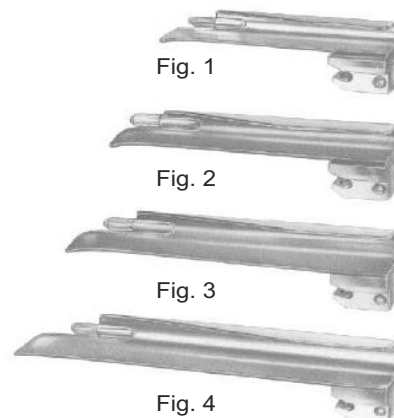
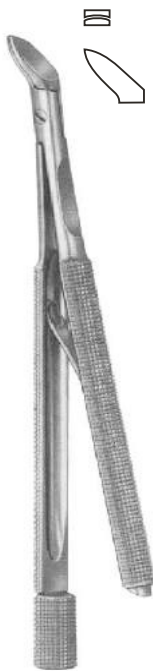

Fig. 1 Working Length, 70 mm (Children's)  
Fig. 2 Working Length, 90 mm (Adolescent's)  
Fig. 3 Working Length, 110 mm (Women's)  
Fig. 4 Working Length, 135 mm (Men's)

# Razor Blade Holders & Breakers



**02-180**  
TROUTMAN-CHRIS  
Size: 100 mm



**02-181**  
TROUTMAN-CHRIS  
Size: 100 mm



**02-182**  
Size: 110 mm

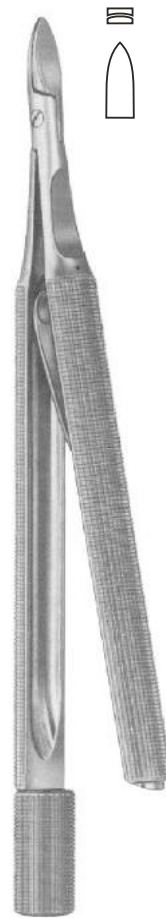

**02-183**  
CASTROVIEJO  
Size: 130 mm



**02-184**  
Size: 185 mm

# Scalpel Handles

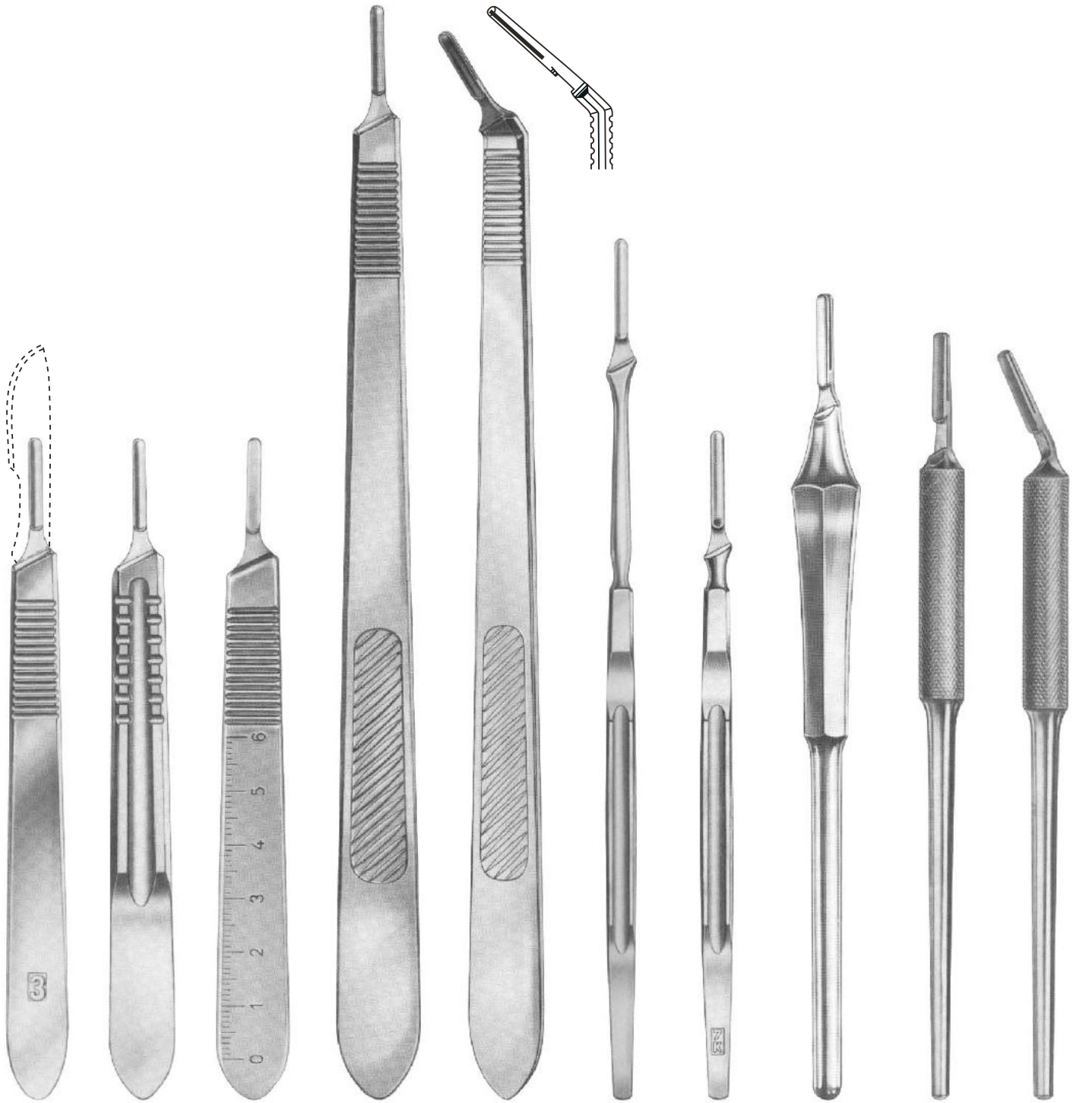

**02-192**  
STANDARD  
No. 3  
Solid

**02-193**  
No. 3  
Solid

**02-194**  
No. 3  
Solid

**02-195**  
No. 3 L  
Straight  
Solid

**02-196**  
No. 3 L  
Angled  
Solid

**02-197**  
No. 7  
Solid

**02-198**  
No. 7 K  
Solid

**02-199**  
Hollow-Round

**02-200**  
No. 3  
Straight  
Solid

**02-201**  
No. 3  
Angled  
Solid



# Micro Scissors, "Spring Type" Bayonet Shape

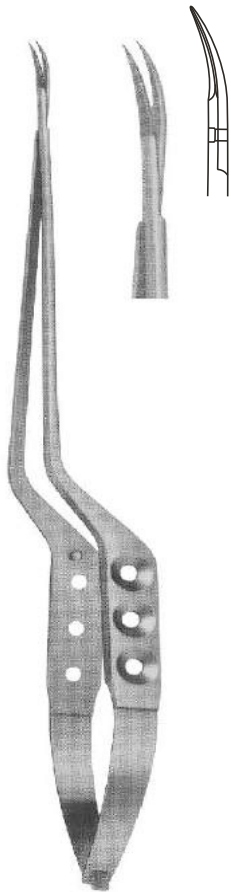

**03-122**  
YASARGIL  
Size: 245 mm

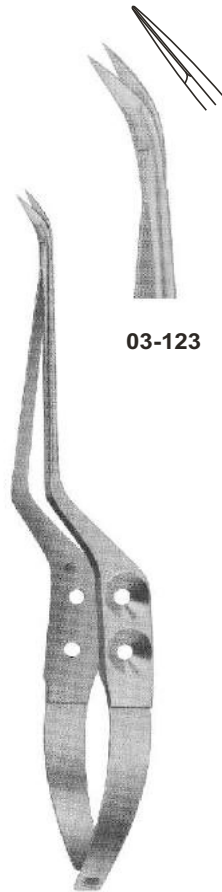

**03-123**

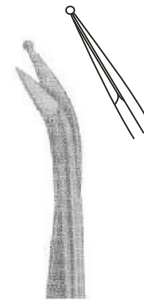

**03-124**

**03-123 - 124**  
Laterally Angled  
Size: 200 mm

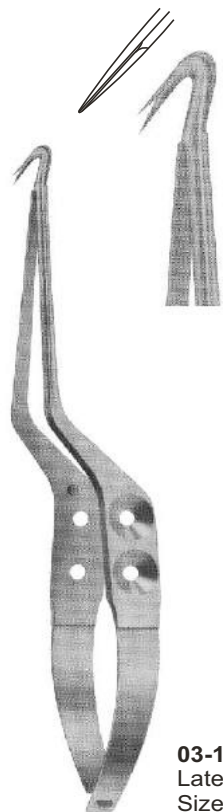

**03-125**  
Laterally Angled  
Size: 190 mm

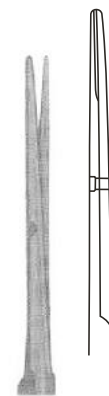

**03-126**

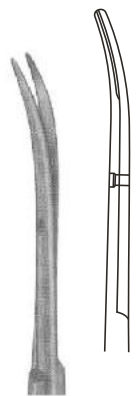

**03-127**



**03-126 - 127**  
YASARGIL  
Size: 225 mm

# Surgical Scissors

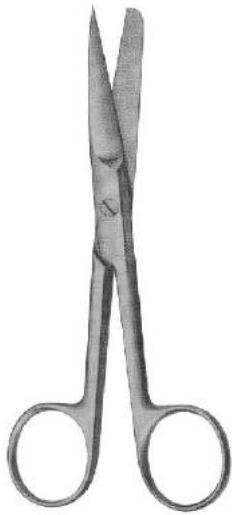

**03-204 - 206**  
DEAVER  
With flat lock

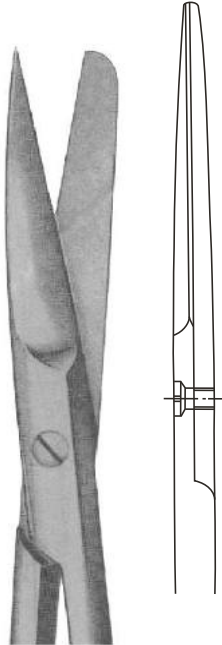

**03-204**  
Size: 145 mm

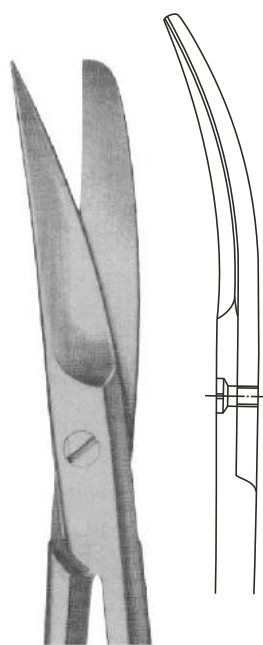

**03-205**  
Size: 145 mm

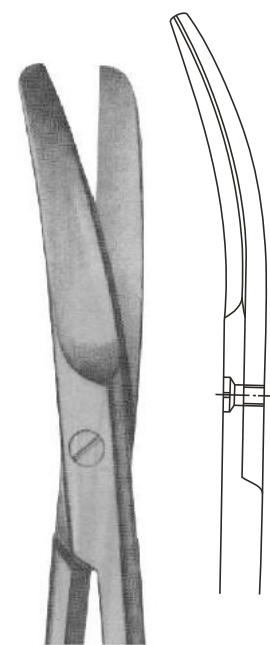

**03-206**  
Size: 145 mm



**03-207 - 209**  
Incision Scissors

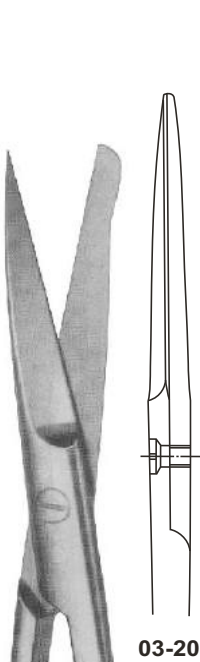

**03-207**  
Size: 130 mm



**03-208**  
Size: 145 mm

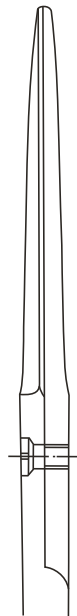

**03-209**  
Size: 165 mm

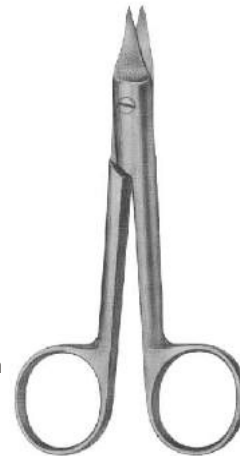

**03-210**  
SYSTRUNK  
Nail Splitting Scissors

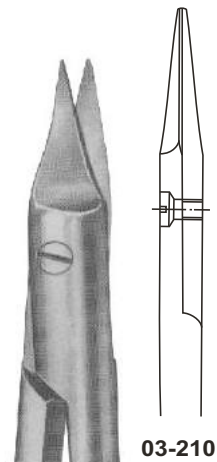

**03-210**  
Size:  
130 mm

# Dissecting & Surgical Scissors

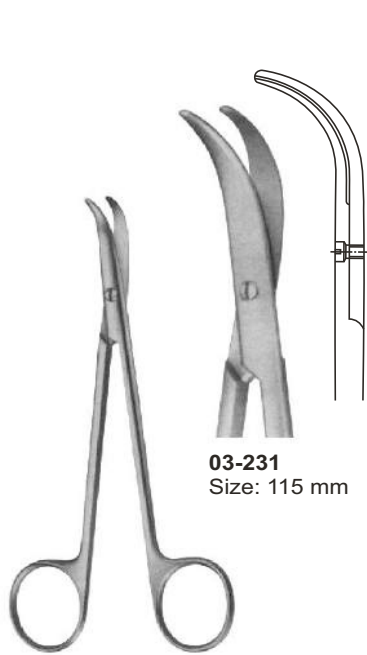

**03-231**  
Size: 115 mm

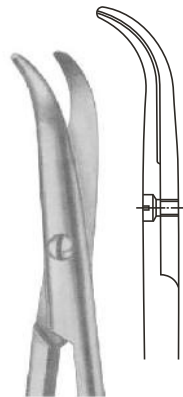

**03-232**  
Size: 135 mm

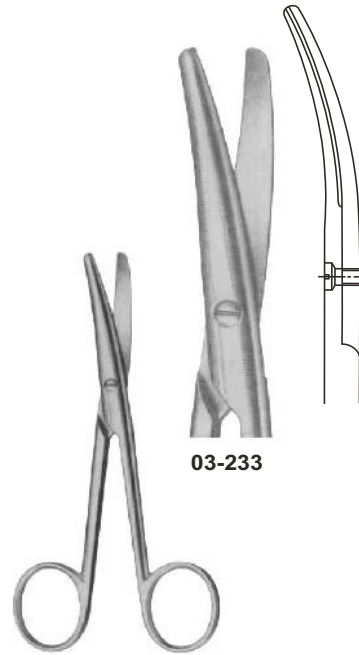

**03-233**

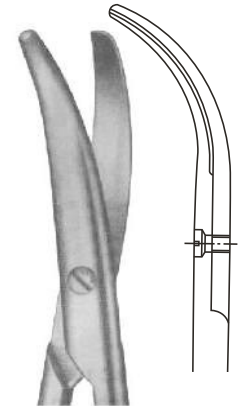

**03-234**

**03-231 - 232**  
FOMON  
Lower lateral scissors

**03-233 - 234**  
LANDOLT  
Enucleation scissors  
Size: 120 mm

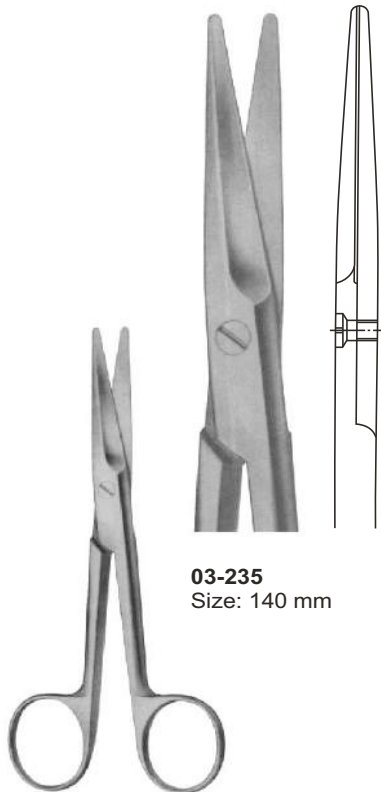

**03-235**  
Size: 140 mm

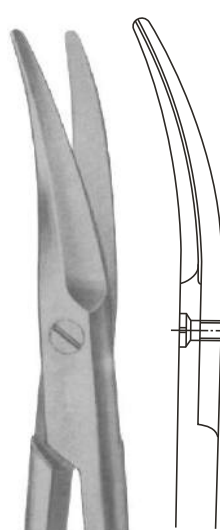

**03-238 - 240**  
MAYO  
**03-238** (140 mm)  
**03-239** (155 mm)  
**03-240** (170 mm)

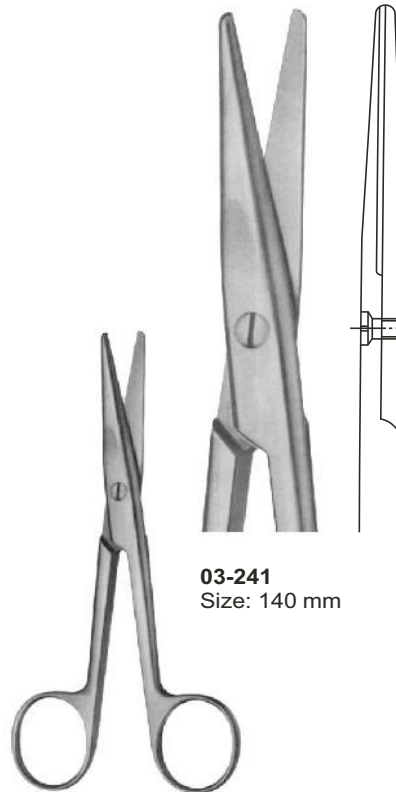

**03-241**  
Size: 140 mm

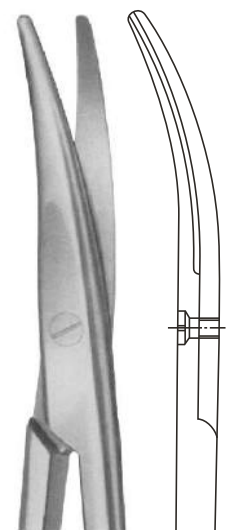

**03-243 - 244**  
MAYO-STILLE  
**03-243** (140 mm)  
**03-244** (170 mm)

**03-235 - 237**  
MAYO  
**03-235** (140 mm)  
**03-236** (155 mm)  
**03-237** (170 mm)

**03-241 - 242**  
MAYO-STILLE  
**03-241** (140 mm)  
**03-242** (170 mm)

# Dissecting Scissors

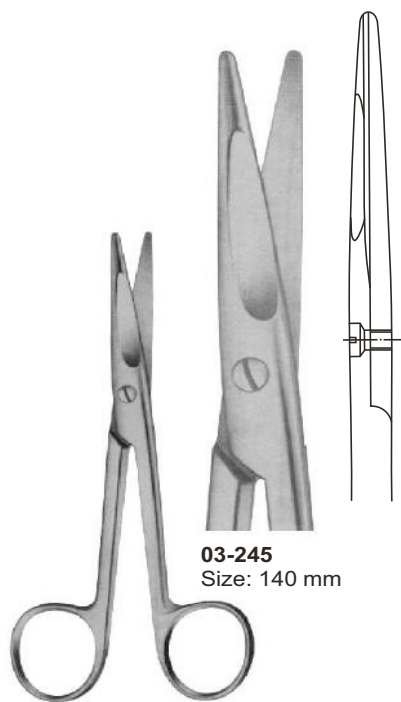

**03-245**  
Size: 140 mm

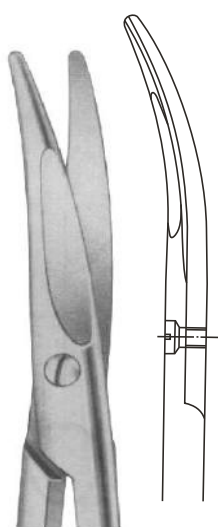

**MAYO-STILLE**  
**03-247 - 248**  
Size: 140 mm  
**03-248**  
Size: 170 mm

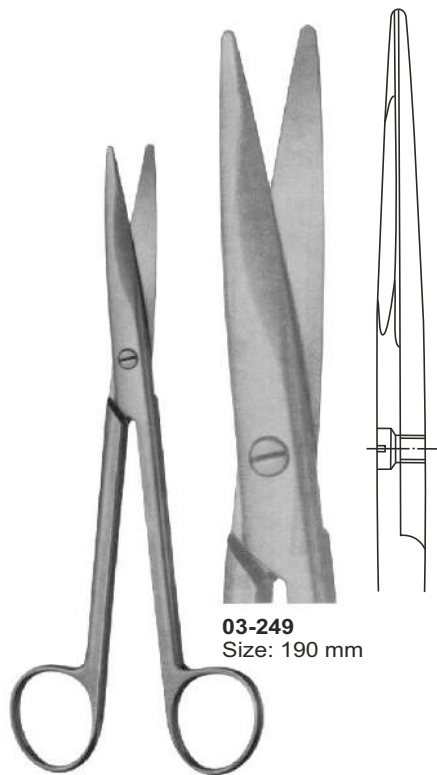

**03-249**  
Size: 190 mm

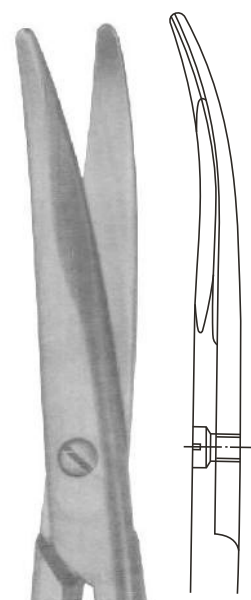

**MAYO**  
**03-251**  
Size: 190 mm  
**03-252**  
Size: 215 mm

**03-245 - 246**  
**MAYO-STILLE**  
With chamfered blades  
**03-245** (140 mm)  
**03-246** (170 mm)

**MAYO**  
With chamfered blades  
**03-249** (190 mm)  
**03-250** (215 mm)

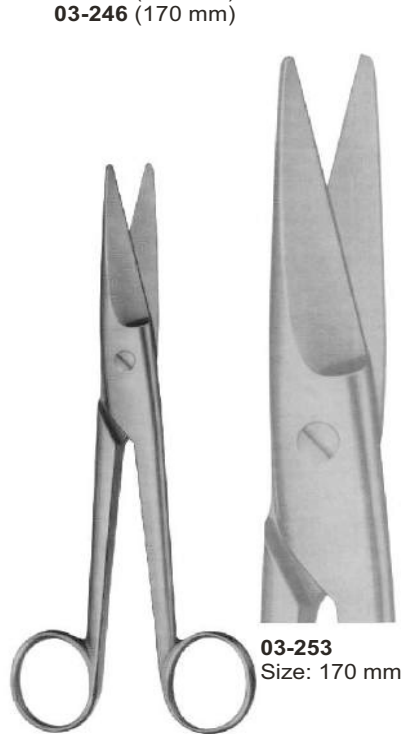

**03-253**  
Size: 170 mm

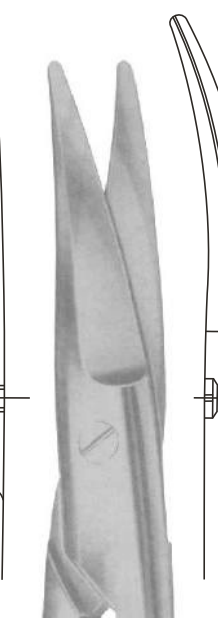

**03-254**  
Size: 170 mm

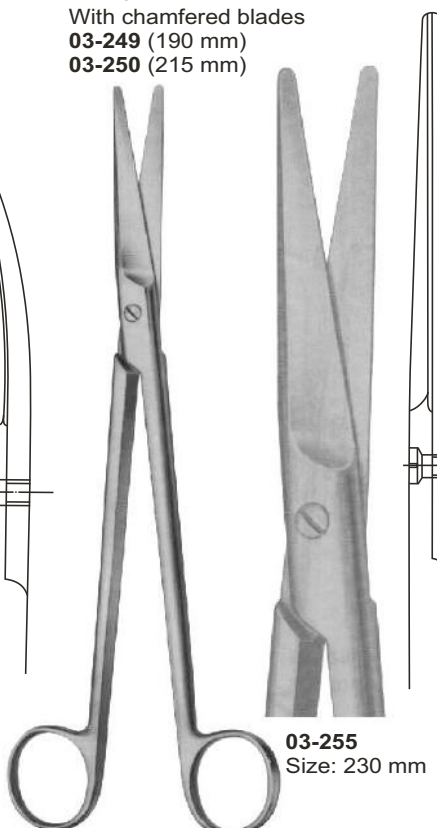

**03-255**  
Size: 230 mm

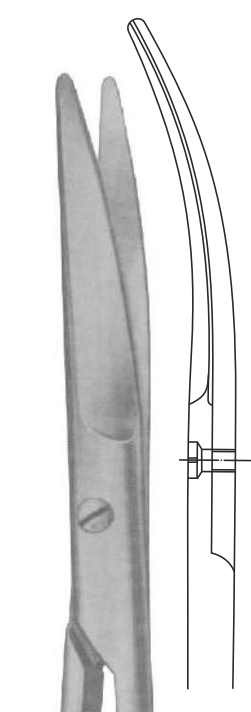

**03-256**  
Size: 230 mm

**03-253 - 254**  
**MAYO-NOBLE**  
Broad pattern

**03-255 - 256**  
**MAYO-HARRINGTON**

# Dissecting Scissors

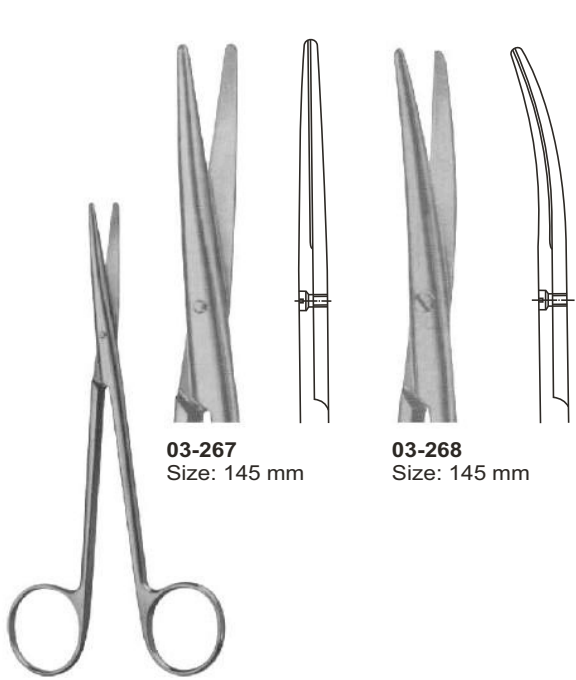

**03-267**  
Size: 145 mm

**03-268**  
Size: 145 mm

**03-267 - 268**  
BABY - METZENBAUM

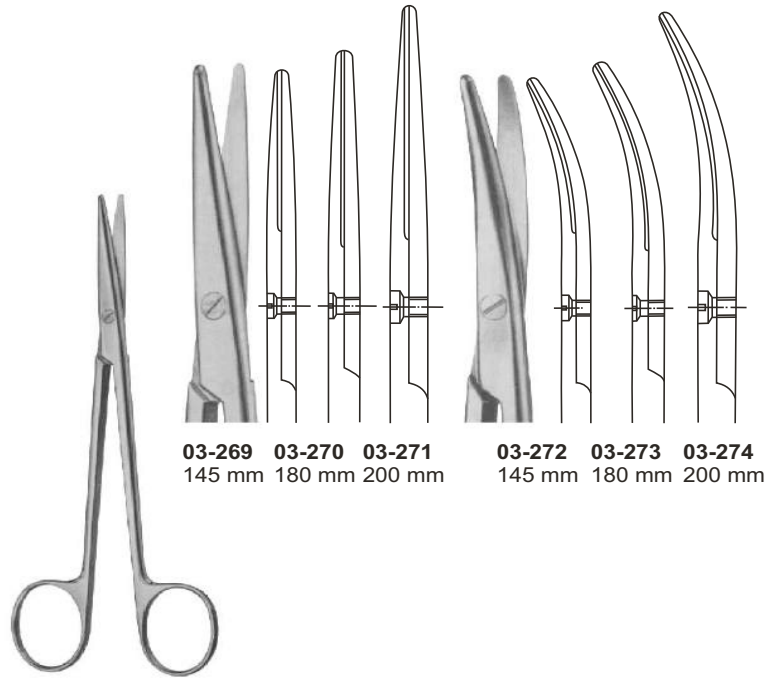

**03-269** 145 mm

**03-270** 180 mm

**03-271** 200 mm

**03-272** 145 mm

**03-273** 180 mm

**03-274** 200 mm

**03-269 - 274**  
METZENBAUM



**03-275 - 282**  
NELSON - METZENBAUM

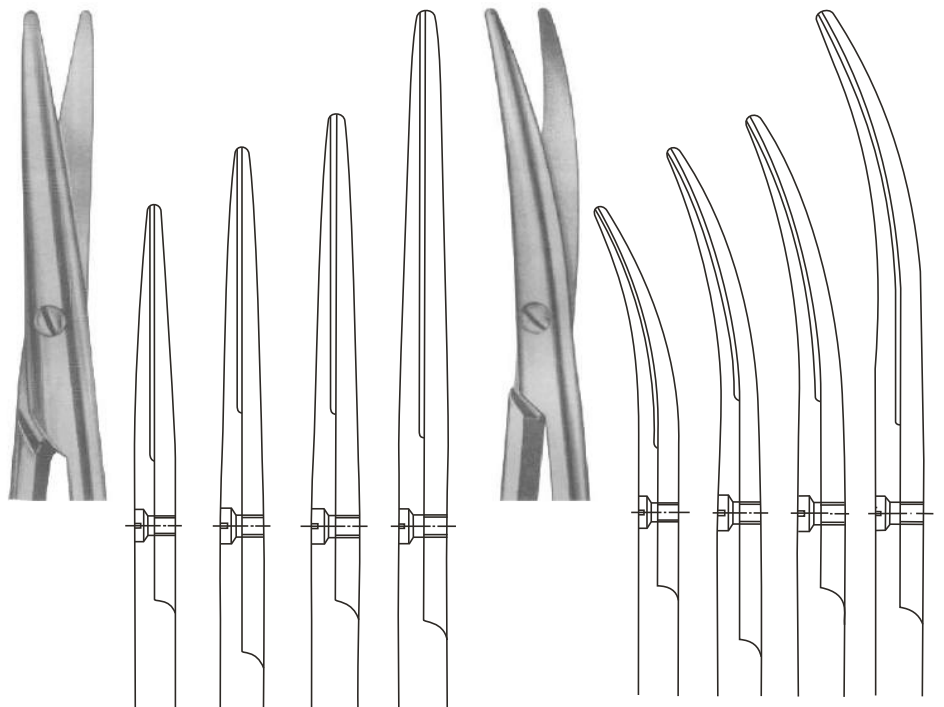

**03-275** 230 mm

**03-276** 250 mm

**03-277** 280 mm

**03-278** 305 mm

**03-279** 230 mm

**03-280** 250 mm

**03-281** 280 mm

**03-282** 305 mm

# Vessel Scissors

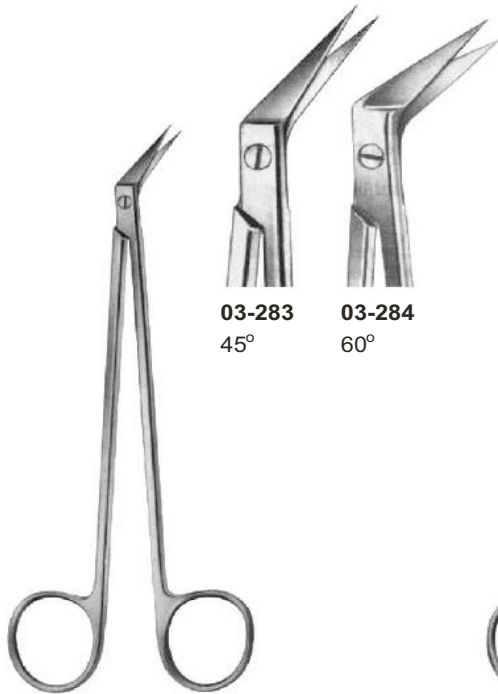

**03-283**  
45°

**03-284**  
60°

**03-283 - 284**  
DE BAKEY  
Size: 155 mm

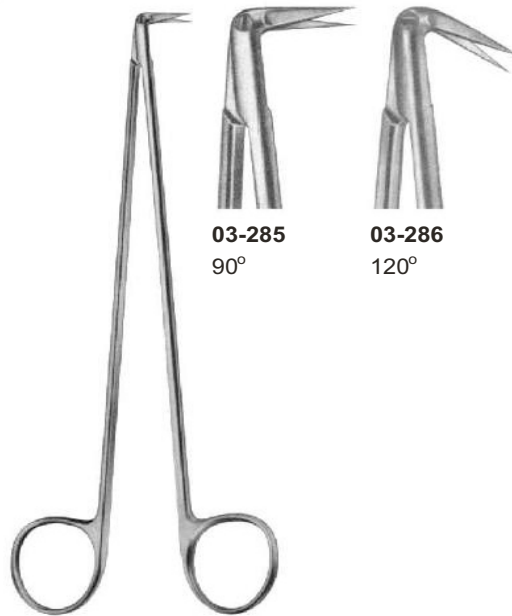

**03-285**  
90°

**03-286**  
120°

**03-285 - 286**  
DIETRICH  
Size: 170 mm

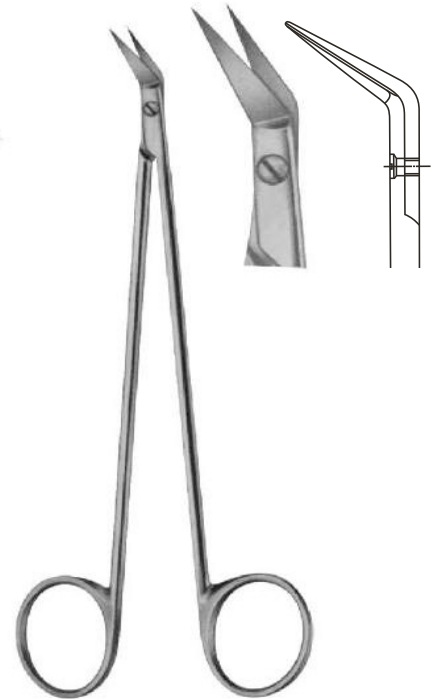

**03-287**  
POTTS-SMITH  
Size: 180 mm

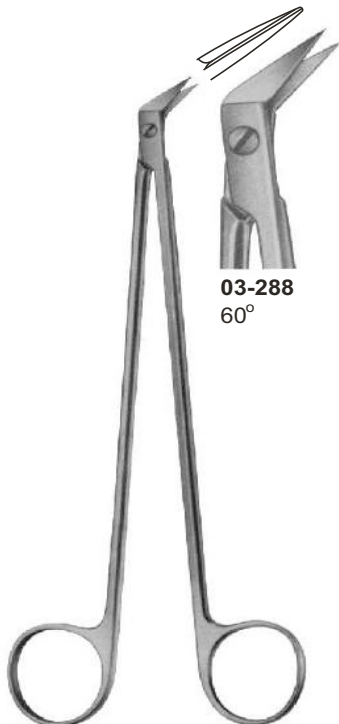

**03-288**  
60°

**03-288**  
POTTS-SMITH  
Size: 180 mm

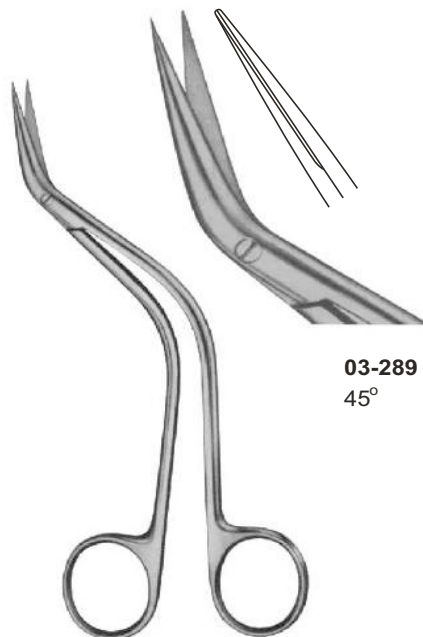

**03-289**  
45°

**03-289**  
DEBAKEY  
Size: 155 mm

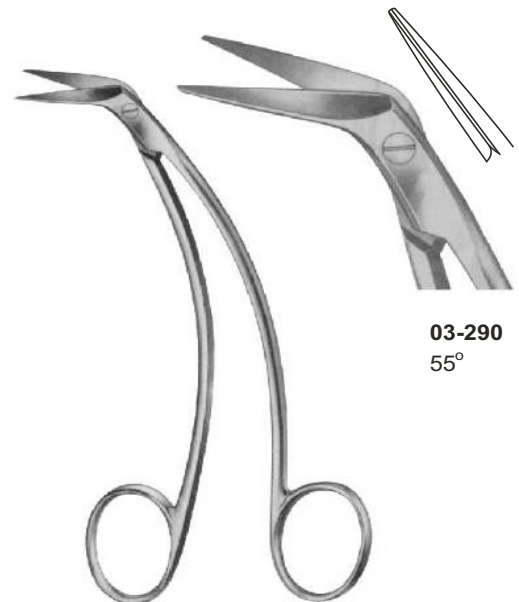

**03-290**  
55°

**03-290**  
FAVOLORO  
Size: 140 mm

# Operating and Gynaecology Scissors



**03-319**  
SCHUMACHER  
Umbilical Cord Scissors  
Size: 155 mm



**03-320**  
Umbilical Cord Scissors  
Size: 105 mm

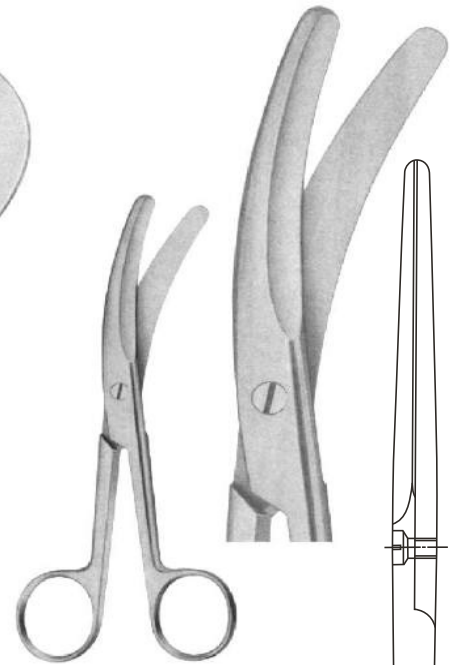

**03-321**  
Umbilical Cord Scissors



135 mm

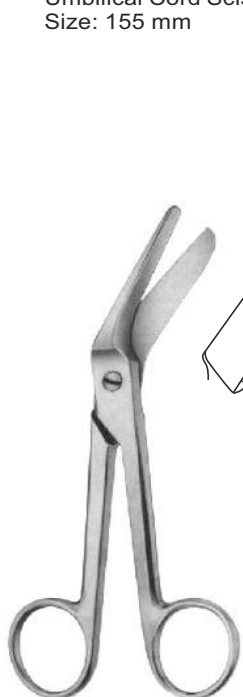

**03-322 - 323**  
BRAUN-STADLER  
Empisiotomy Scissors

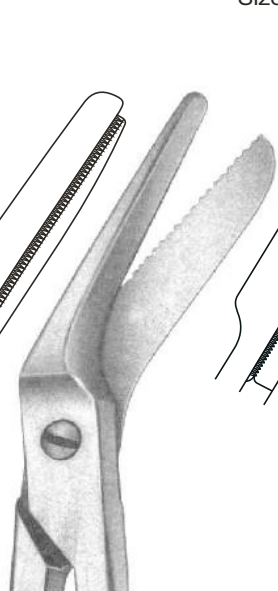

**03-322**  
145 mm

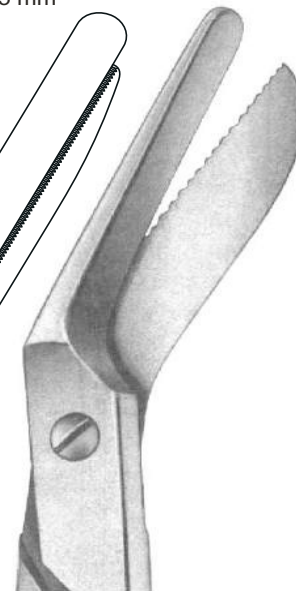

**03-323**  
200 mm



**03-324**  
DAMMSCHERE  
Empisiotomy Scissors  
240 mm

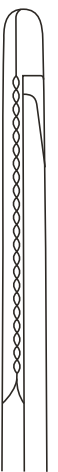

# Bandage and Cloth Scissors



**03-352**  
UNIVERSAL AND BANDAGE SCISSORS  
180 mm

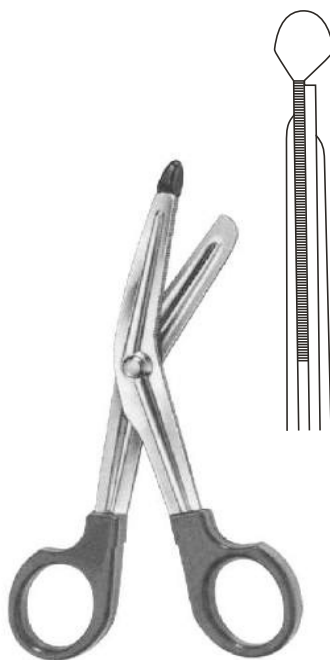

**03-353**  
LISTER  
Size: 145 mm

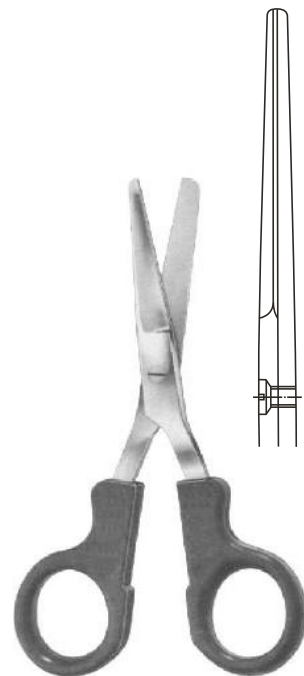

**03-354**  
LISTER  
Size: 145 mm

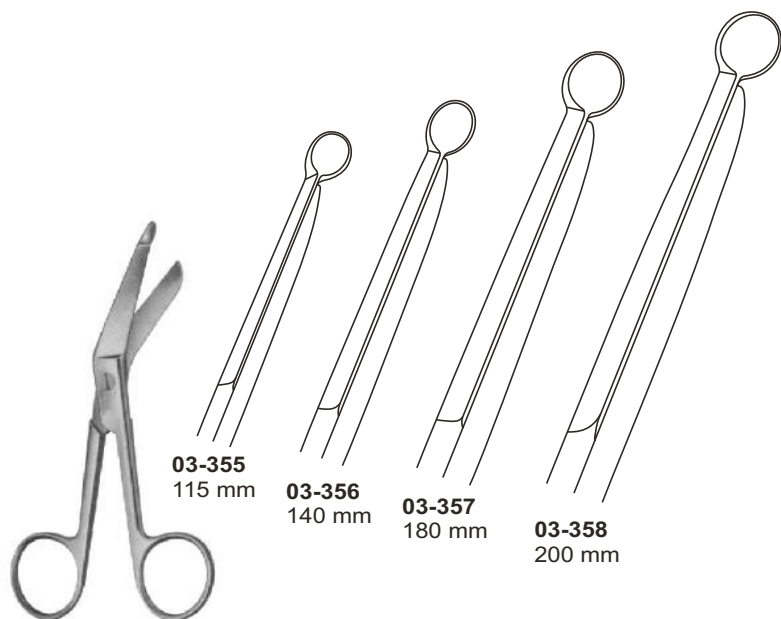

**03-355 - 358**  
LISTER

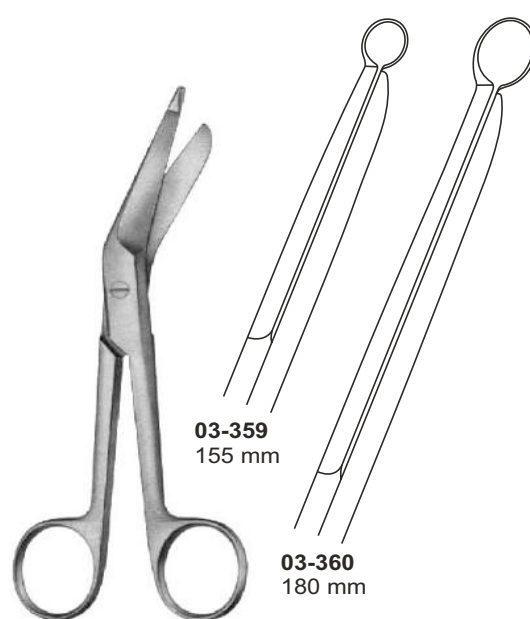

**03-359 - 360**  
LISTER



# Forceps for Grasping Tissue, Tumors

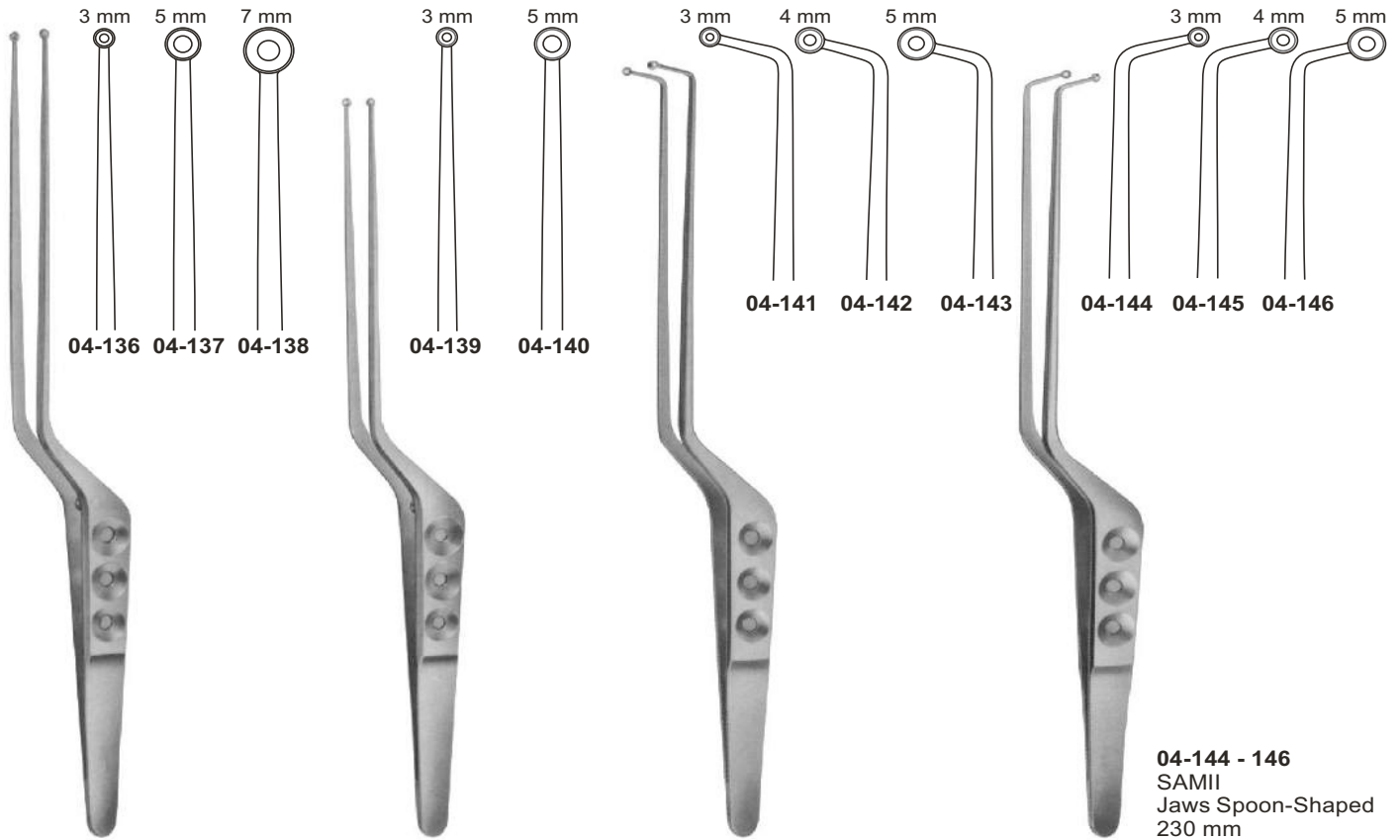

**04-136 - 138**  
YASARGIL-SAMI  
Jaws Spoon-Shaped  
240 mm

**04-139 - 140**  
YASARGIL  
Jaws Spoon-Shaped  
220 mm

**04-141 - 143**  
SAMII  
Jaws Spoon-Shaped  
230 mm

**04-144 - 146**  
SAMII  
Jaws Spoon-Shaped  
230 mm

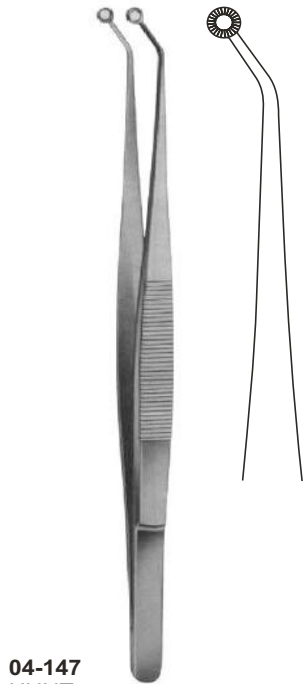

**04-147**  
HUNT  
Tumor-and Vessel Forceps  
200 mm

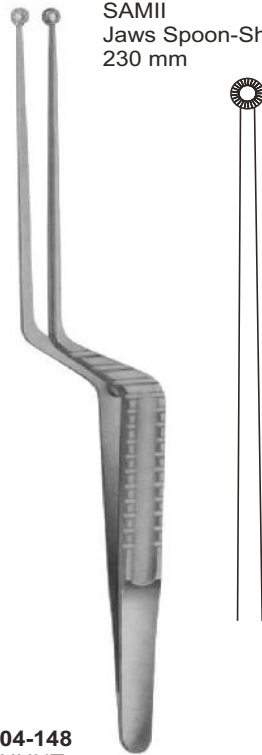

**04-148**  
HUNT  
Tumor-and Vessel Forceps  
200 mm

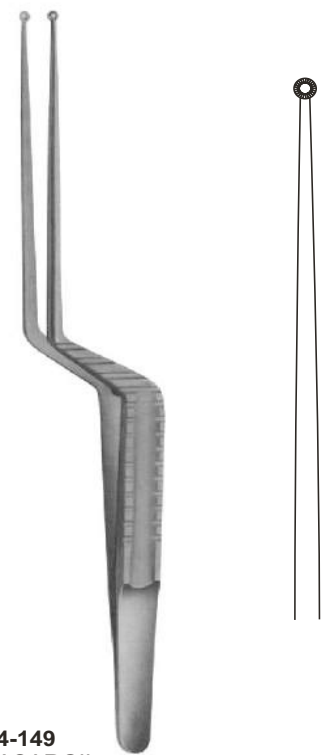

**04-149**  
YASARGIL  
Tumor-and Vessel Forceps  
200 mm

# Tissue Forceps, Lung Dissecting Forceps



**04-291 - 293**  
**LANE**



**04-294 - 295**  
**STRASSBURGER**  
**MODELL**



**04-296**  
**BONNEY**

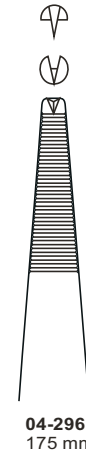

**04-297**  
**RUSS.MODELL**  
200 mm

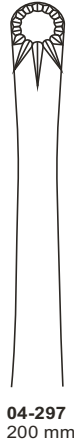

**04-298**  
**TUTTLE**  
Lung Dissecting Forceps  
230 mm

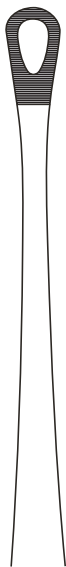

**04-299**  
**NELSON**  
Lung Dissecting Forceps  
230 mm

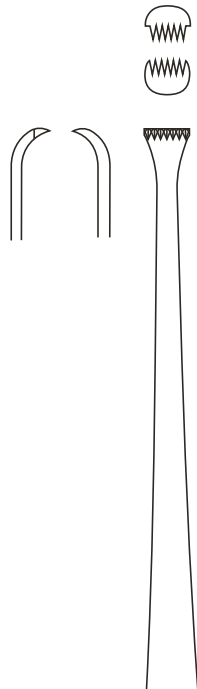

**04-300**  
**DUVAL**  
Intestinal Forceps  
140 mm



**04-301**  
**DENIS-BROWNE**  
Intestinal Forceps  
190 mm



## Sponge and Dressing Forceps

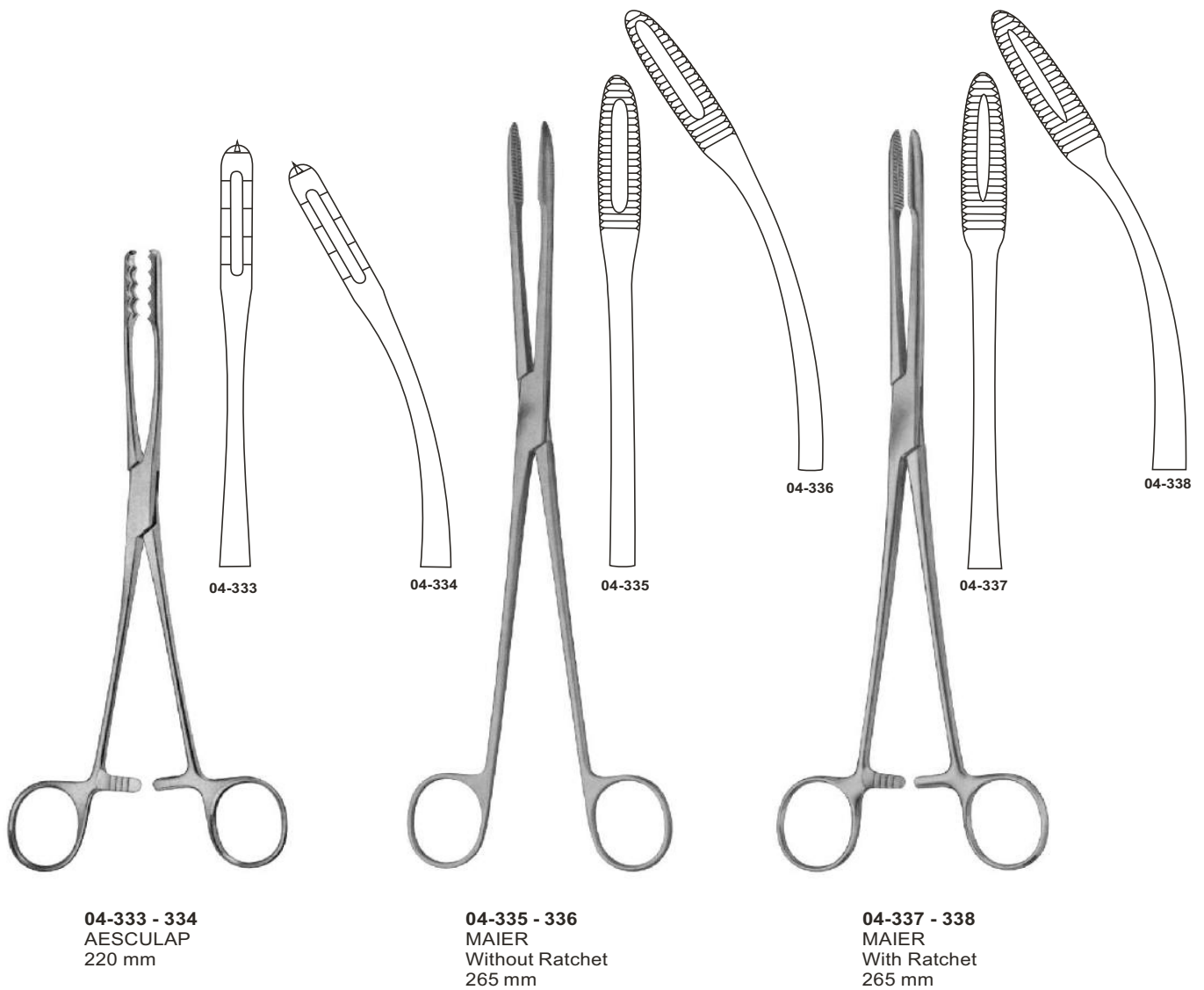

**Dressing, Sponge holding, Organ  
and Tissue Grasping Forceps**

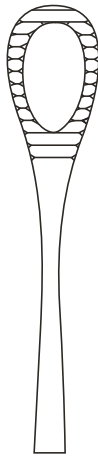
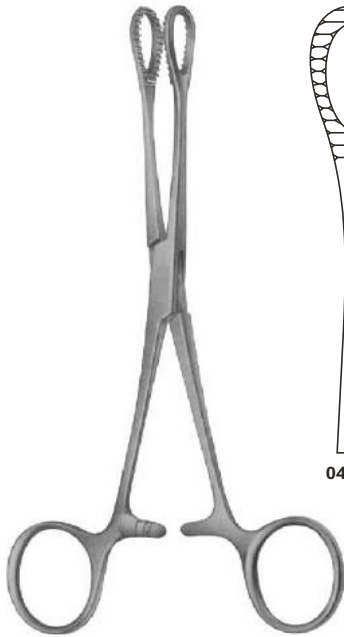

04-344



04-345

**04-344 - 345  
FOERSTER-BALLENGER  
180 mm**

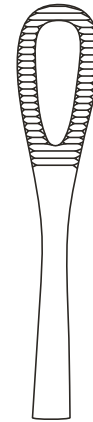

04-346  
180 mm

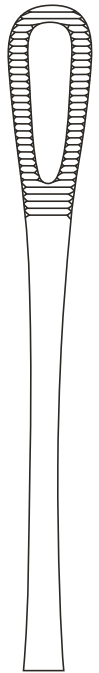

04-347  
250 mm

**04-346 - 347  
RAMPLEY**

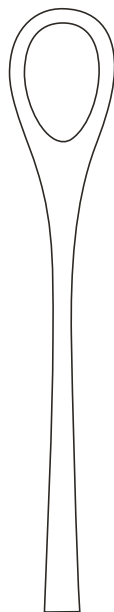

04-348  
Smooth Jaws



04-349  
Smooth Jaws

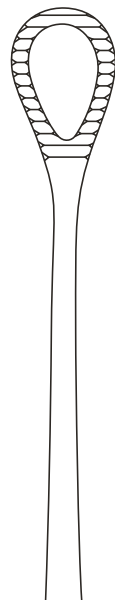

04-350  
Serrated Jaws

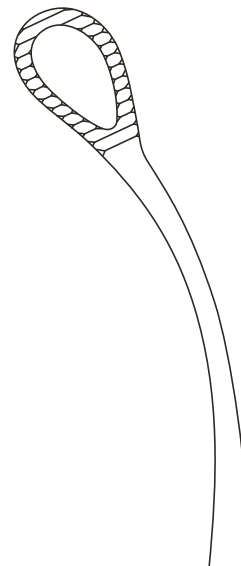

04-351  
Serrated Jaws

**04-348 - 351  
FOERSTER-BALLENGER  
240 mm**

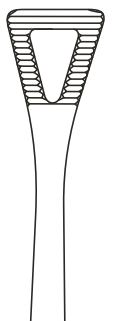
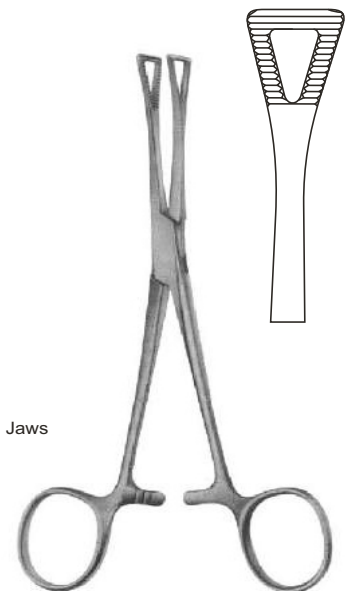

**04-352  
PENNINGTON  
155 mm**

## Organ - and Tissue Grasping Forceps

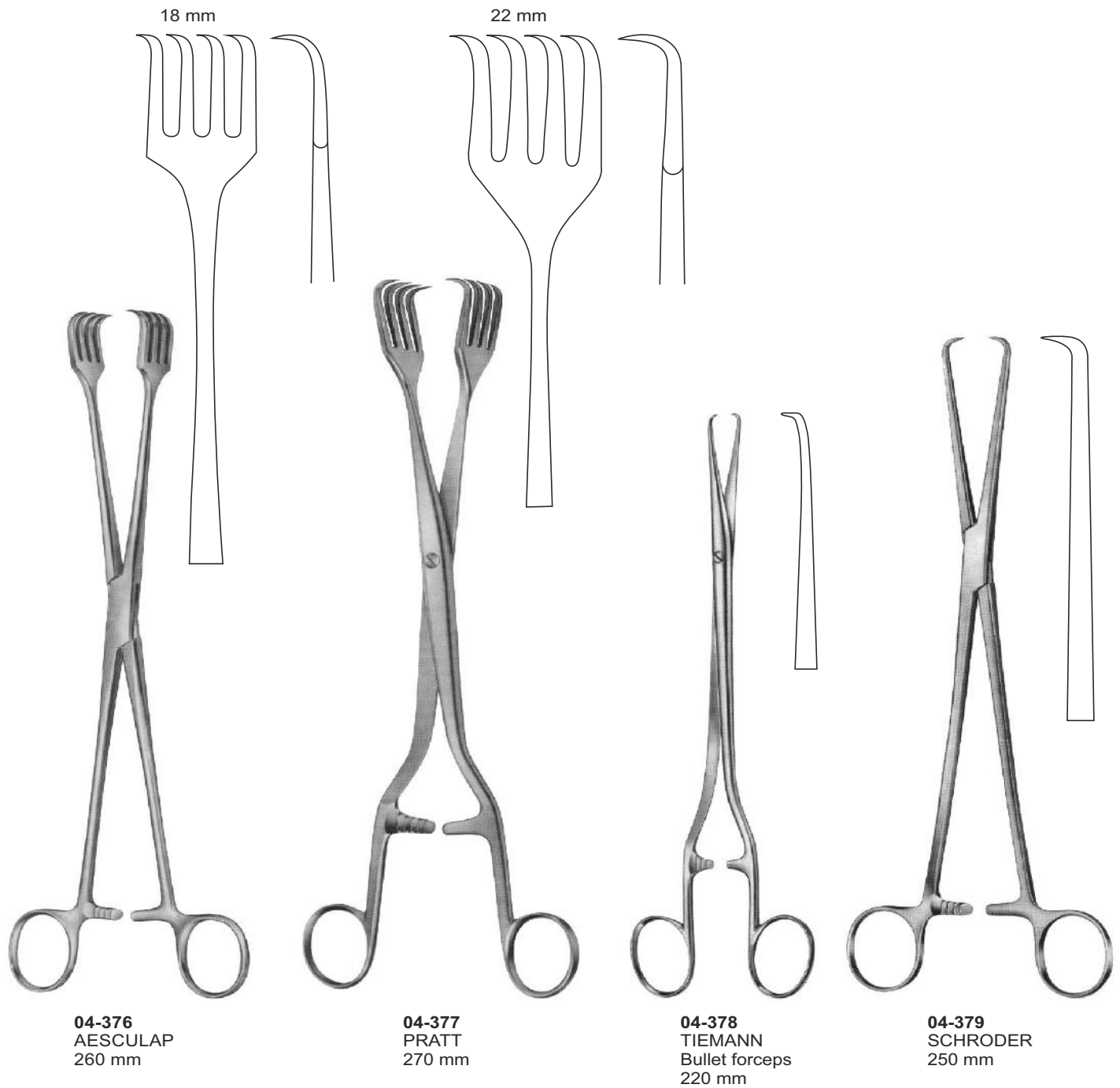

# Haemostatic Forceps

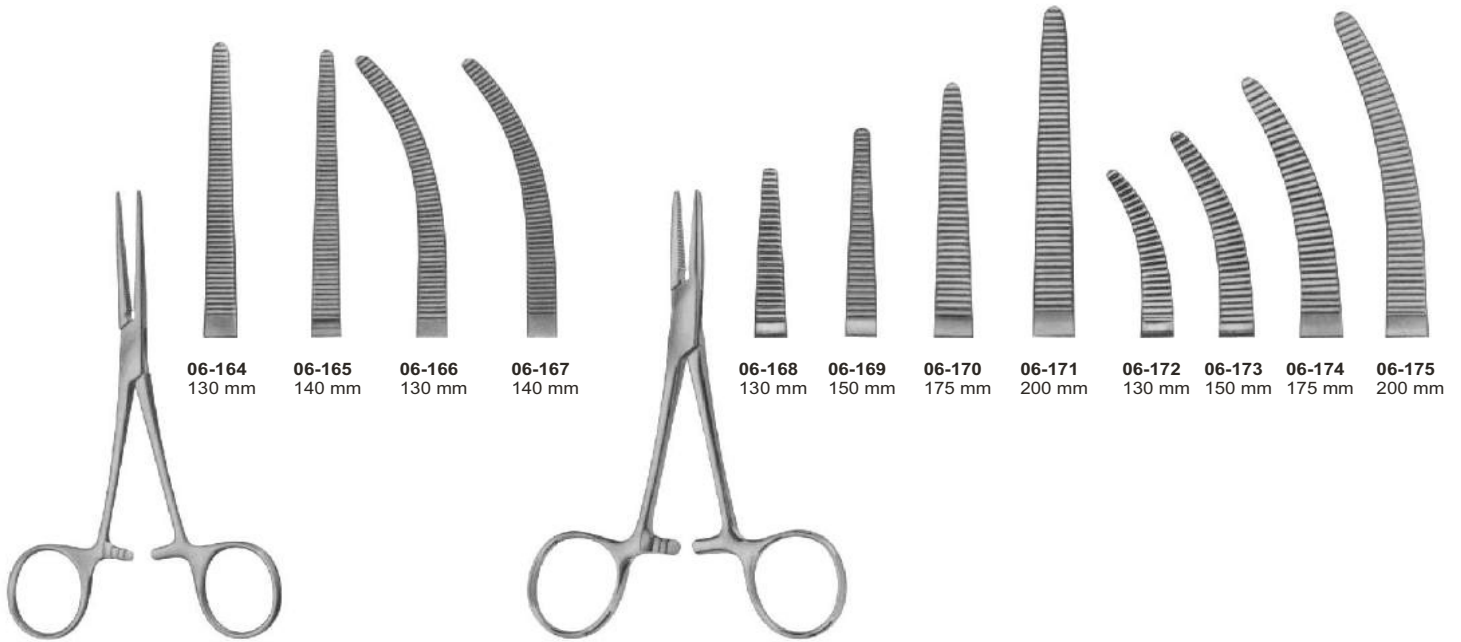

**06-164 - 167**  
PEAN  
Slender type

**06-168 - 175**  
SPENCER-WELLS  
Slender type

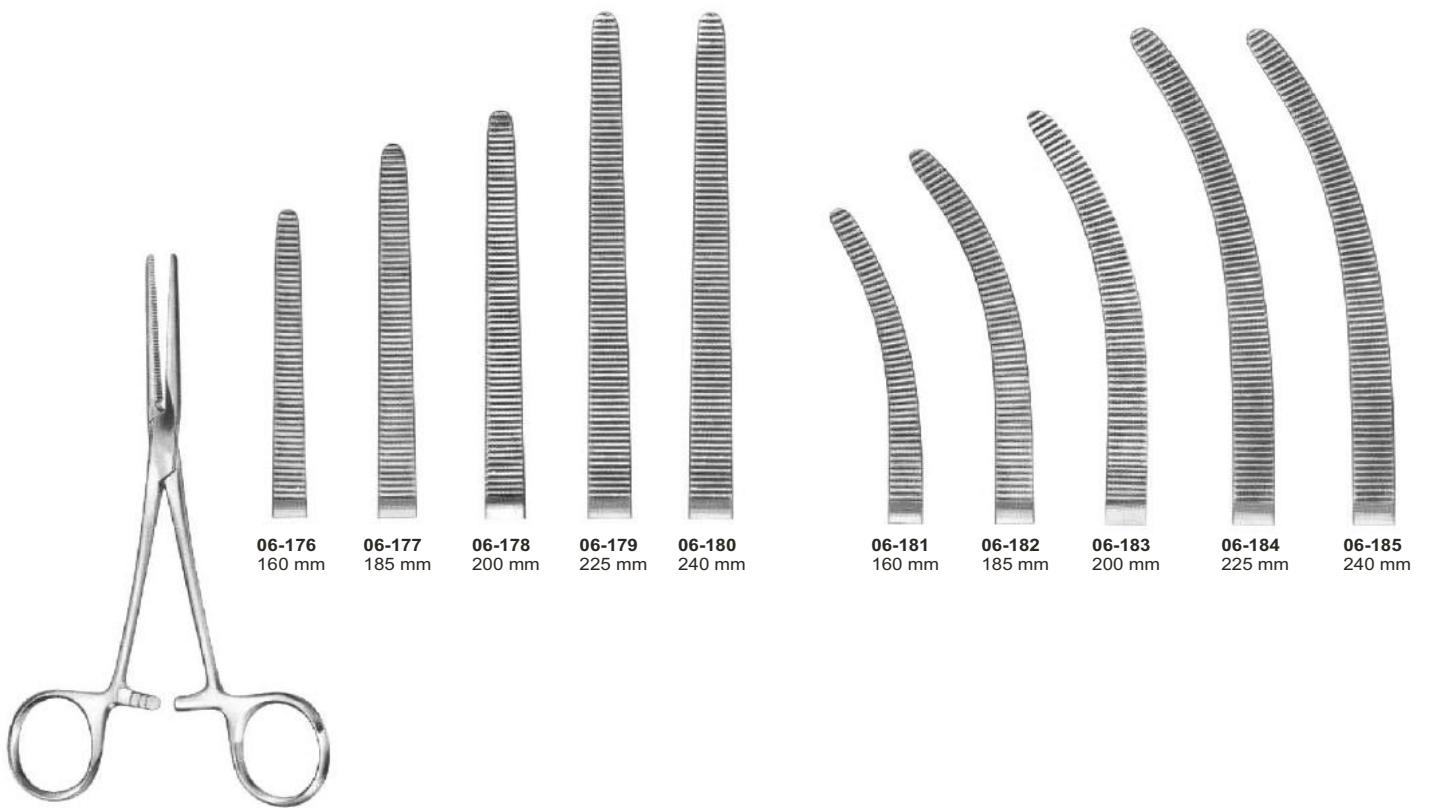

**06-176 - 185**  
ROCHESTER-PEAN

# Dissecting- and Ligature Forceps



**06-252**  
MIXTER-O'SHAUGNESSY  
190 mm



**06-253**  
HEISS  
195 mm



**06-254 - 258**  
RUMEL  
240 mm

06-254

06-255

06-256

06-257

06-258



**06-259**  
FINOCHIETTO  
245 mm

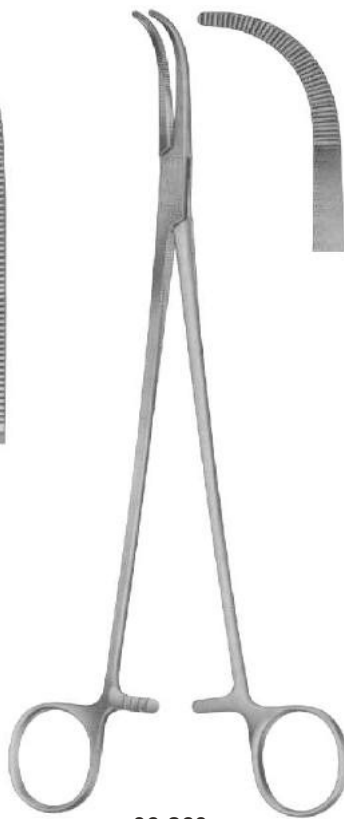

**06-260**  
MIXTER  
230 mm



**06-261**  
LAWRENCE  
270 mm



**06-262 - 263**  
ZENKER

06-262  
300 mm

06-263  
290 mm

# Hysterectomy Forceps and Vaginal Clamps and Compression Forceps

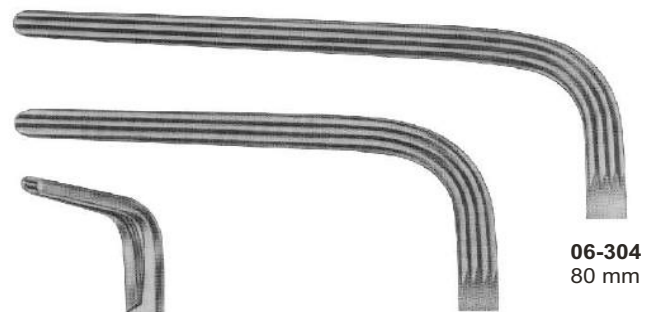
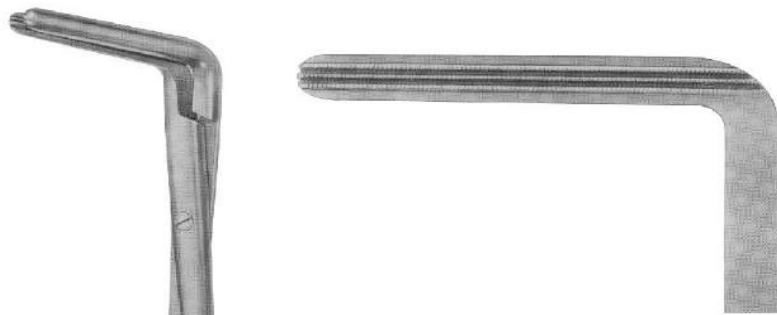



# Needle Holders For Micro Surgery



**07-101**  
ROHRSCHEIDER  
With copper inserts  
100 mm



**07-102**  
KALT  
With catch  
135 mm



**07-103**  
ARRUGA  
With catch  
135 mm

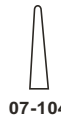

07-104



07-105

**07-104 - 105**  
CASTROVIEJO  
With catch  
145 mm



07-106 07-107

**07-106 - 107**  
CASTROVIEJO  
With Catch  
160 mm



07-108



07-109

**07-108 - 109**  
Without catch  
185 mm



07-110  
Without catch



07-111  
With catch

**07-110 - 111**  
JACOBSON  
185 mm



**07-112**  
Without catch  
195 mm



07-113



07-114

**07-113 - 114**  
YASARGIL  
With catch  
200 mm

# Retractors, Deep form

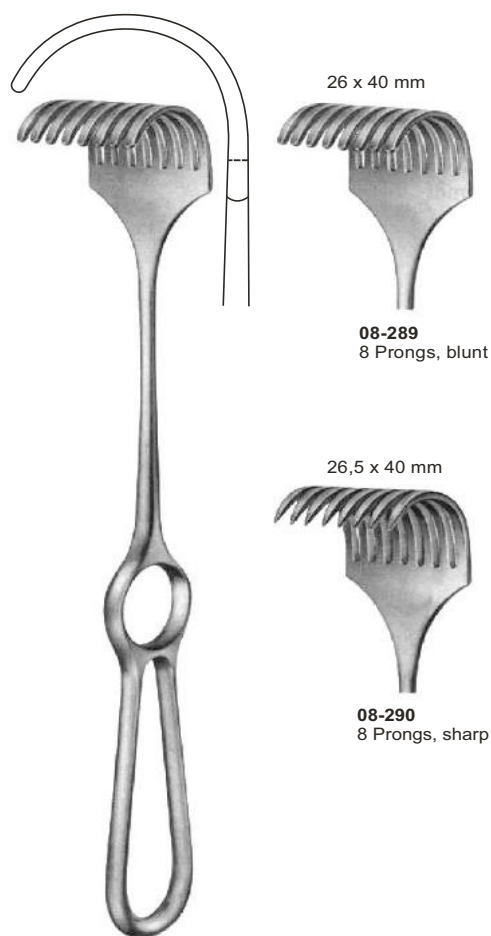

26 x 40 mm

**08-289**  
8 Prongs, blunt

26,5 x 40 mm

**08-290**  
8 Prongs, sharp

**08-289 - 290**  
KORTE  
240 mm



**08-291 - 294**  
ISRAEL  
255 mm

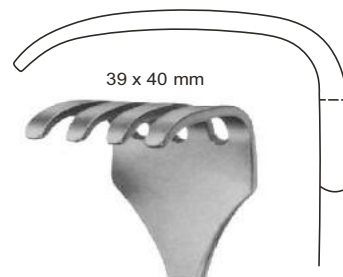

39 x 40 mm

**08-291**  
4 Prongs, blunt

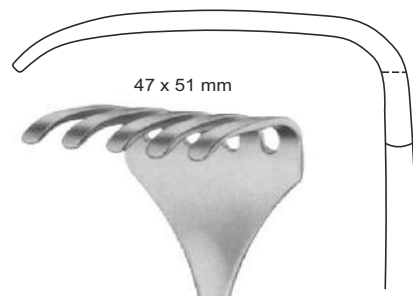

47 x 51 mm

**08-292**  
5 Prongs, blunt

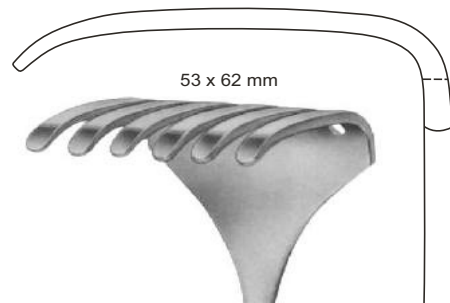

53 x 62 mm

**08-293**  
6 Prongs, blunt

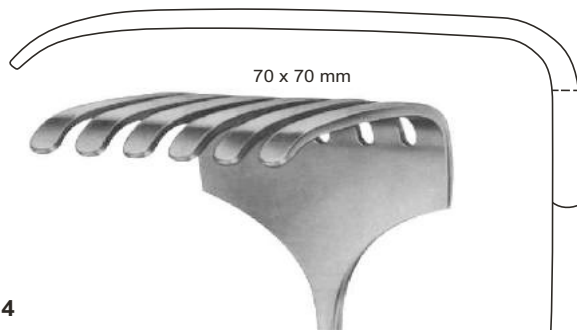

70 x 70 mm

**08-294**  
6 Prongs, blunt

# Retractors



**08-323 - 328**  
HOSEL  
250 mm

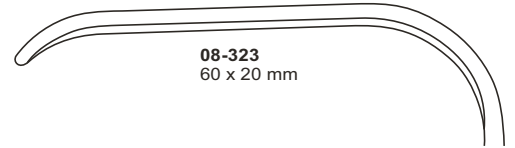

**08-323**  
60 x 20 mm

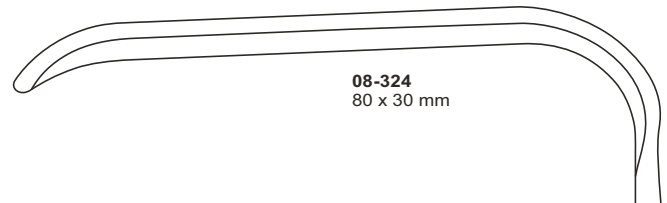

**08-324**  
80 x 30 mm

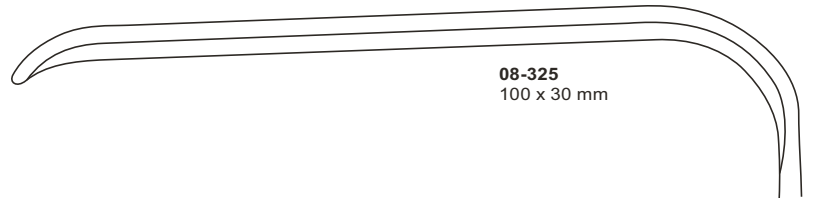

**08-325**  
100 x 30 mm

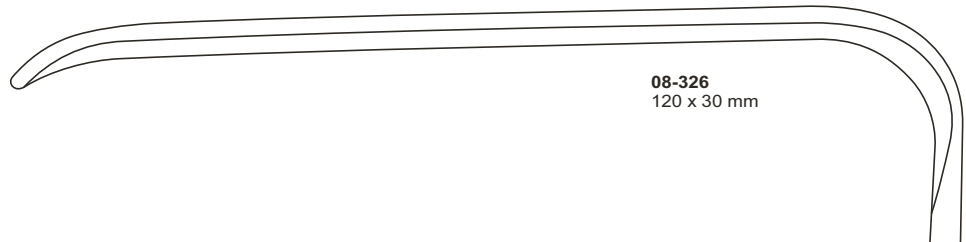

**08-326**  
120 x 30 mm

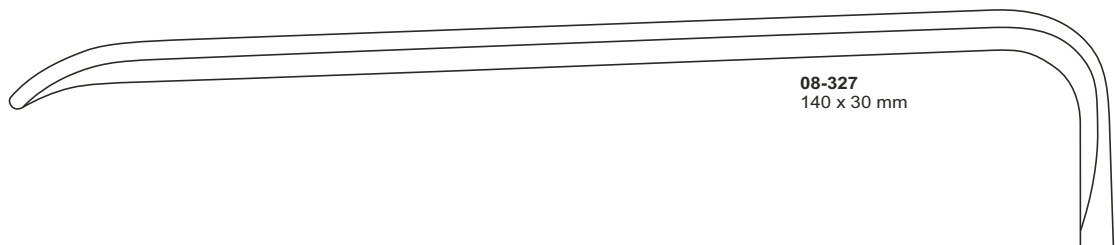

**08-327**  
140 x 30 mm

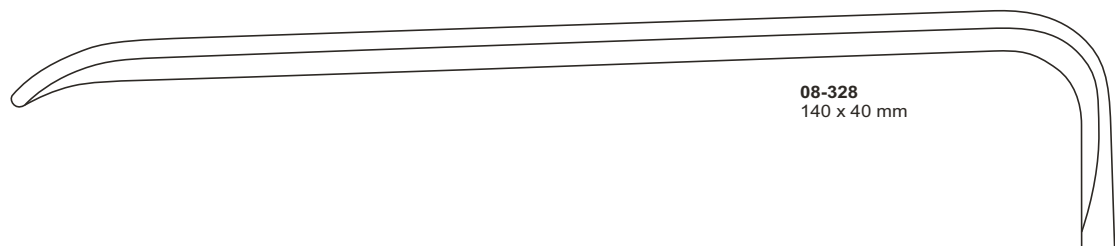

**08-328**  
140 x 40 mm



**08-367**  
DEAVER  
300 mm  
Fig. 3

**08-368**  
DEAVER  
310 mm  
Fig. 4

**08-369**  
DEAVER  
320 mm  
Fig. 5

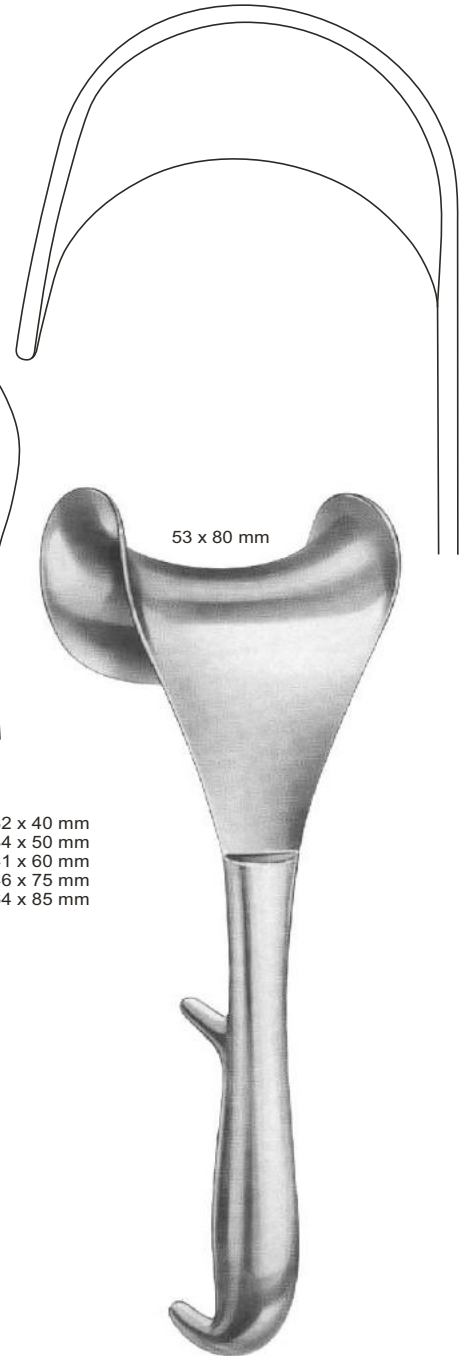
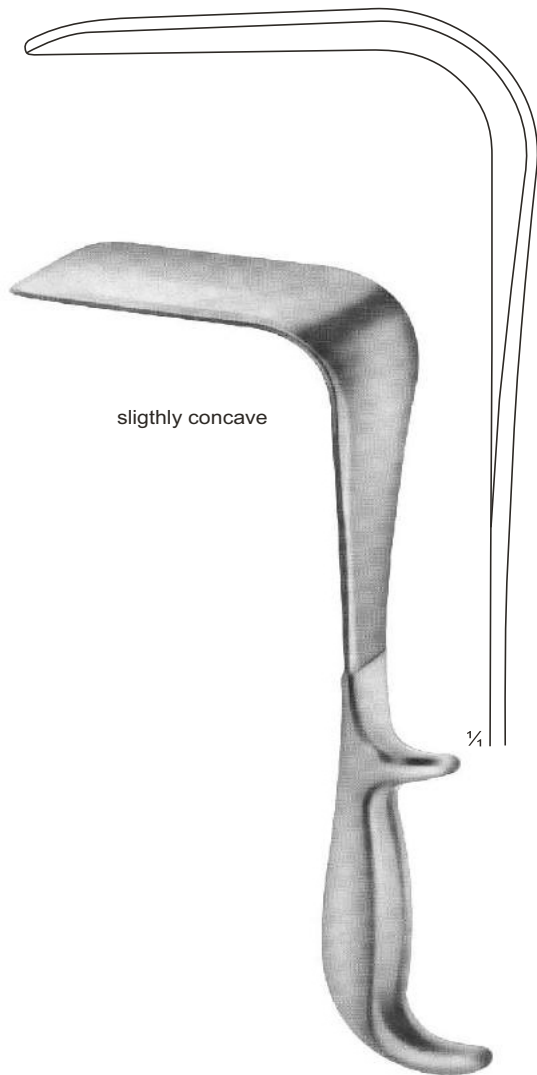

- 08-391 Fig.1 32 x 40 mm
- 08-392 Fig.2 34 x 50 mm
- 08-393 Fig.3 41 x 60 mm
- 08-394 Fig.4 46 x 75 mm
- 08-395 Fig.5 64 x 85 mm

**08-380 - 390**  
DOYEN  
240 mm

**08-391 - 395**  
FRITSCH  
240 mm

**08-396**  
DOYEN  
250 mm

<b>Width of Blades</b>	
35 mm, 45 mm, 60 mm	
<b>Length of Blades</b>	
62 mm	08-380 , 08-381 , 08-382
92 mm	08-383 , 08-384 , 08-385
122 mm	08-386 , 08-387 , 08-388
160 mm	08-389 , 08-390

## Special Retractors



**08-459**  
JOLL ( FRIEDMAN )  
Thyroid- and Vaginal Retractor  
155 mm



**08-460**  
JACKSON BURROWS  
Retractor, blunt  
185 mm



**08-461**  
GELPI  
Vaginal Retractor  
135 mm



**08-462**  
GELPI  
Skin- and Vaginal Retractor  
175 mm



**08-463**  
DE BAKEY  
Femur Retractor  
145 mm

# Abdominal Retractors

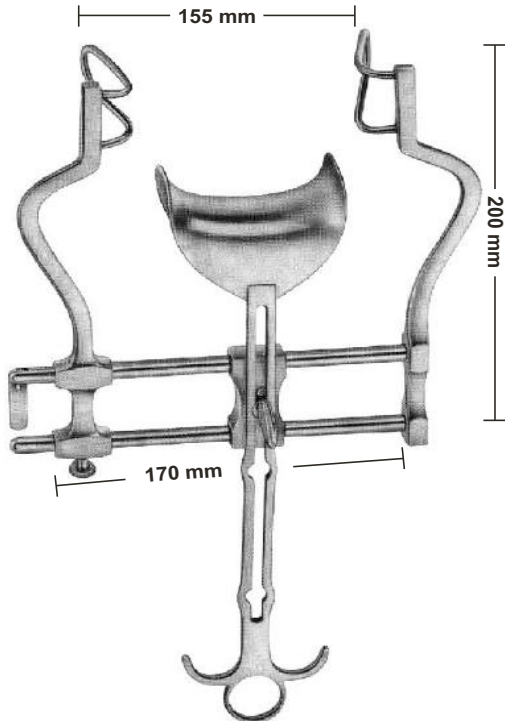

**08-537**  
BALFOUR  
Lateral blades 60 mm deep  
Center blade 47 x 80 mm

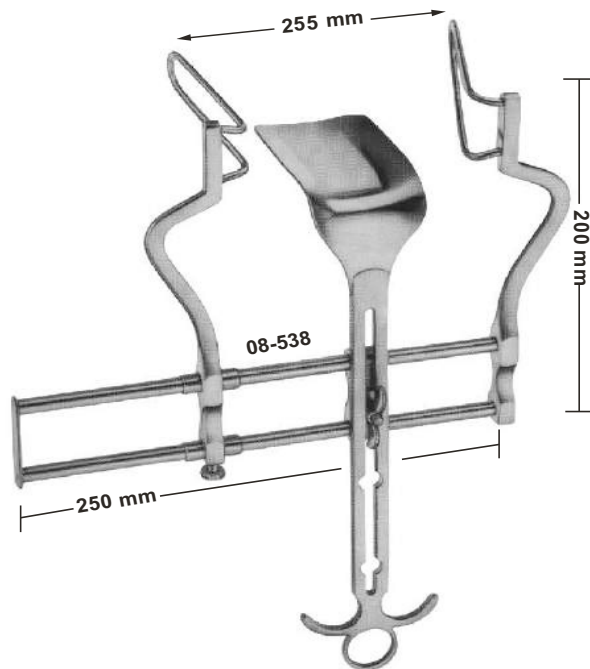

**08-538**  
BALFOUR  
Lateral blades 105 mm deep  
Center blade 107x 59 mm

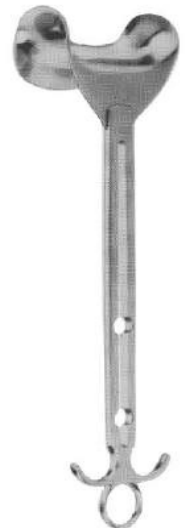

**08-539**  
Center blade only  
54x80 mm

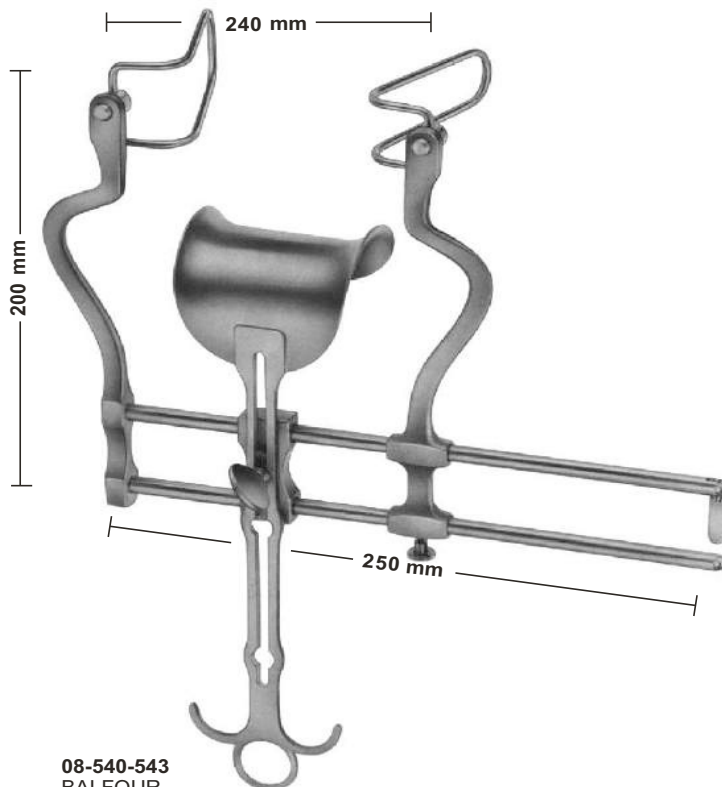

**08-540-543**  
BALFOUR

Spreader only	<b>08-540</b>	<b>08-541</b>	<b>08-542</b>	<b>08-543</b>
Lateral blades	50 mm	60 mm	75 mm	90 mm
Center blade	47 x 80 mm	62x76 mm	80x80 mm	80x80 mm



Sales Unit of blades:PR = pair

Lateral blades  
**08-544**  
50 mm deep  
**08-545**  
60 mm deep  
**08-546**  
75 mm deep  
**08-547**  
90 mm deep

## Gastro-Intestinal Forceps, twin



**09-196**  
LANE  
300 mm

**09-197**  
LANE  
300 mm



# Biopsy forceps for rectum

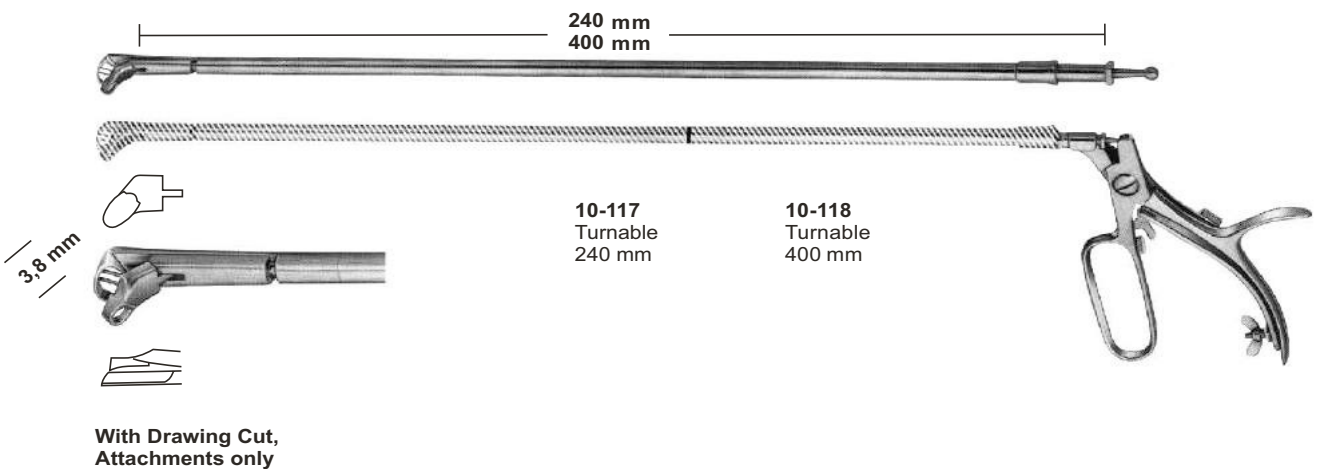
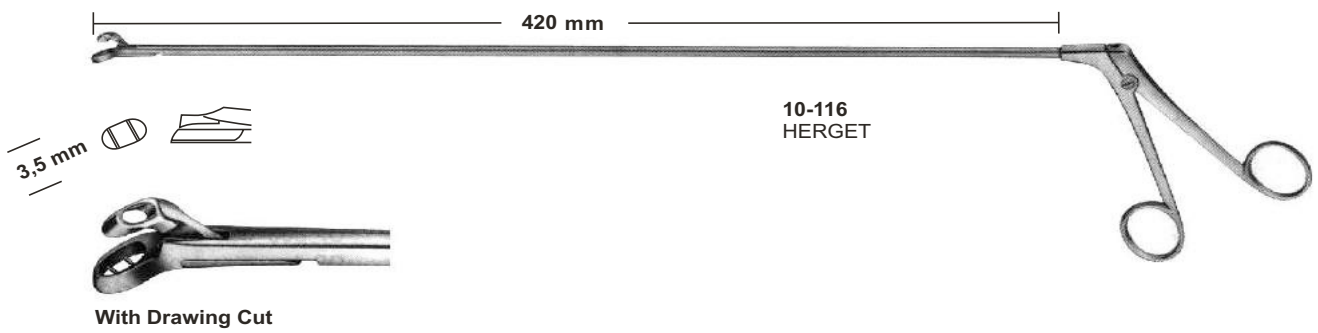
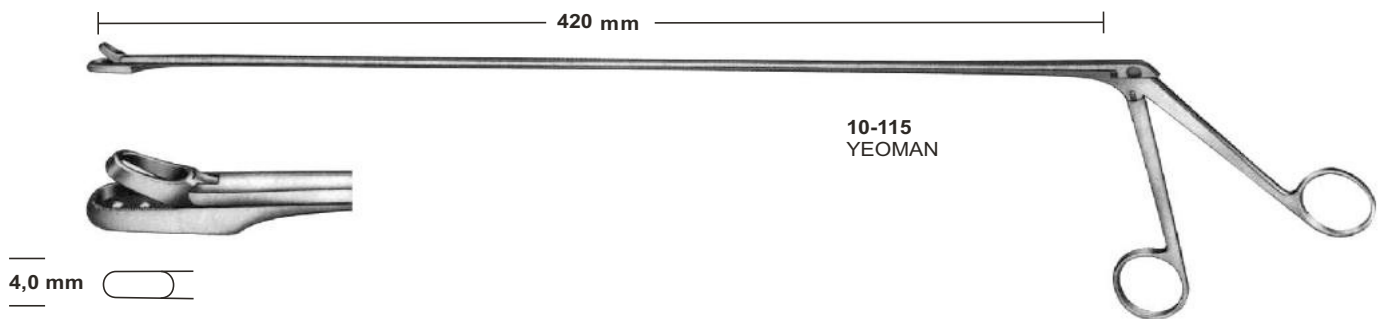
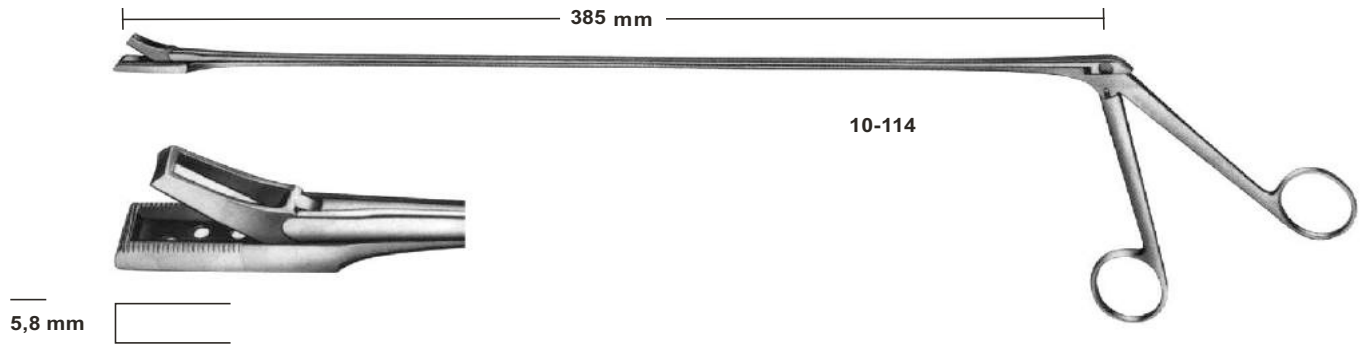

# Gall Bladder Forceps and Gall Duct Scissors

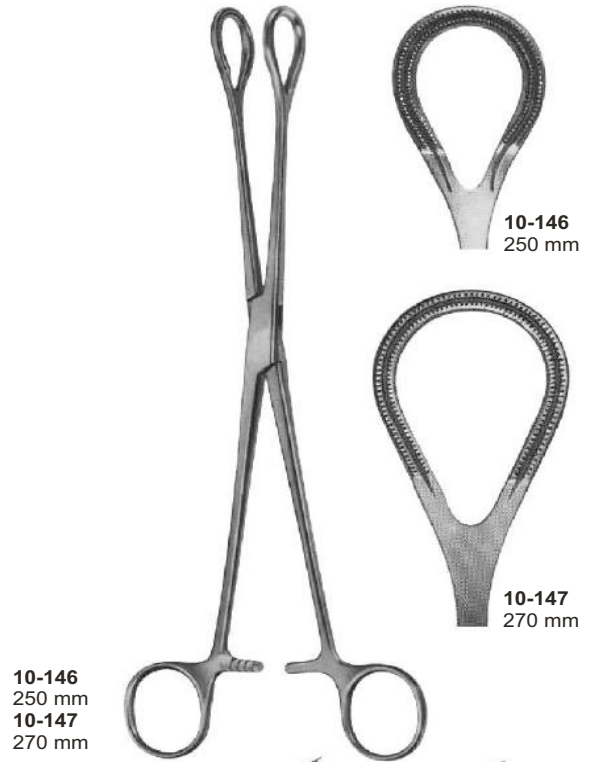
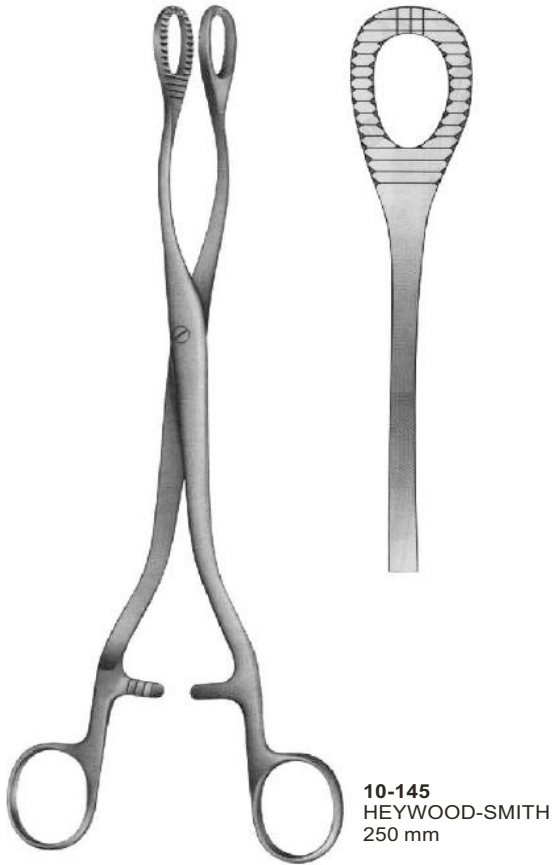

## Vaginal Specula



**12-112 - 115**  
CUSCO  
STANDARD  
**12-112** 80X24 mm  
**12-113** 80X32 mm  
**12-114** 90X36 mm  
**12-115** 110X37 mm



**12-116 - 119**  
CUSCO  
**12-116** 80X24 mm  
**12-117** 80X32 mm  
**12-118** 90X36 mm  
**12-119** 110X37 mm



**12-120 - 122**  
CUSCO  
**12-120** 80X24 mm  
**12-121** 80X32 mm  
**12-122** 115X36 mm



**12-123 - 124**  
SEYFFERT  
**12-123** 100X24 mm  
**12-124** 110X32 mm  
230 mm



**12-125**  
SEMM  
for children  
and virgins  
180 mm

## Vaginal Specula, Sets, Upper & Lower Blades



**12-126 - 128**  
GRAVE  
12-126 75X20 mm  
12-127 95X30 mm  
12-128 105X33 mm



**12-129 - 130**  
PEDERSON  
12-129 100X22 mm  
12-130 120X25 mm



**12-131 - 132**  
BRIESKY  
12-131 72X25 mm / 77X30 mm  
12-132 75X30 mm / 92X38 mm  
170 mm



**12-133 - 134**  
BREISKY  
12-133 100X22 mm  
77 X30 mm  
140 mm  
12-134 120X25 mm  
92 X38 mm  
170 mm



**12-135 - 137**  
SEIDL  
12-135 80X8 mm  
12-136 80X10 mm  
12-137 90X14 mm  
For children and infants  
170 mm



**12-138**  
KRISTELLER  
70X15 mm, ( 170 mm )  
For children



**12-139 - 141**  
SIMS  
12-139 70X26 mm  
75 X30 mm 125 mm  
12-140 75X30 mm  
80 X85 mm 150 mm  
11-141 80X36 mm  
90 X40 mm 175 mm

# Biopsy Forceps

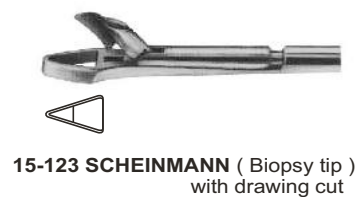
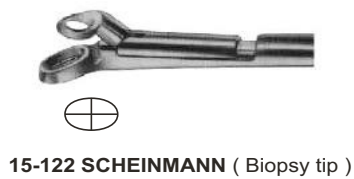
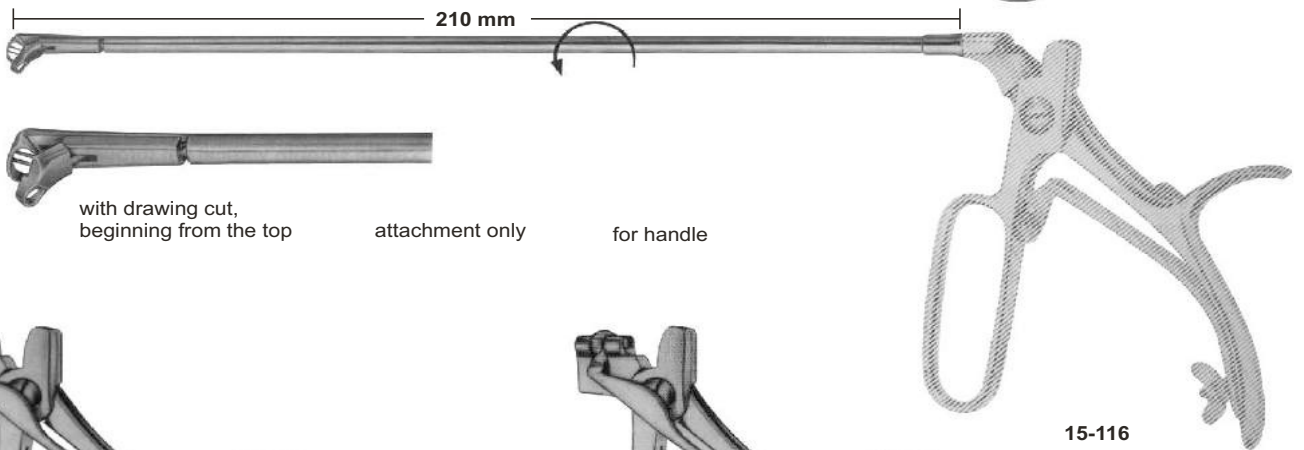
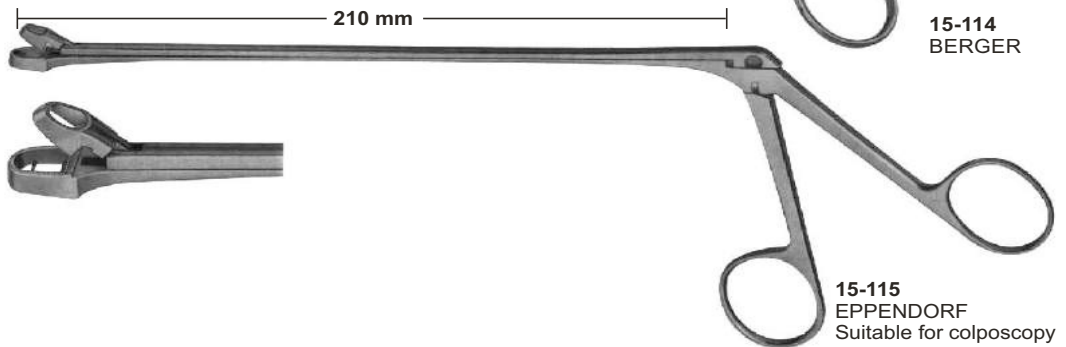
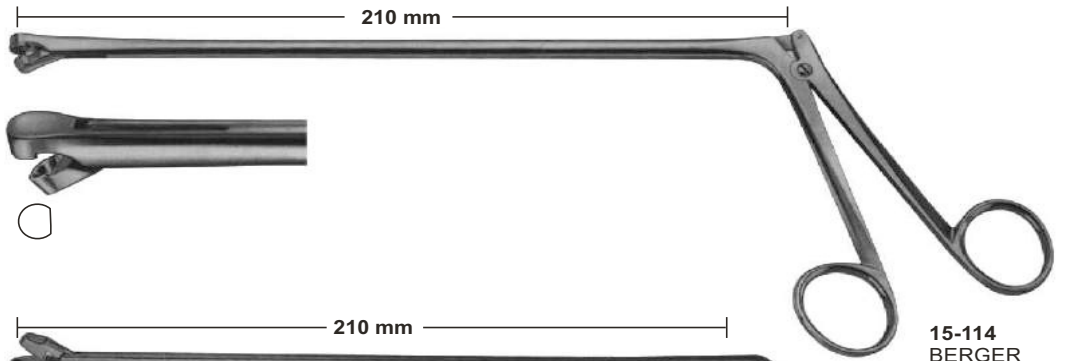

# Anastomosis-and Multi-Purpose-Clamps-Pediatric types

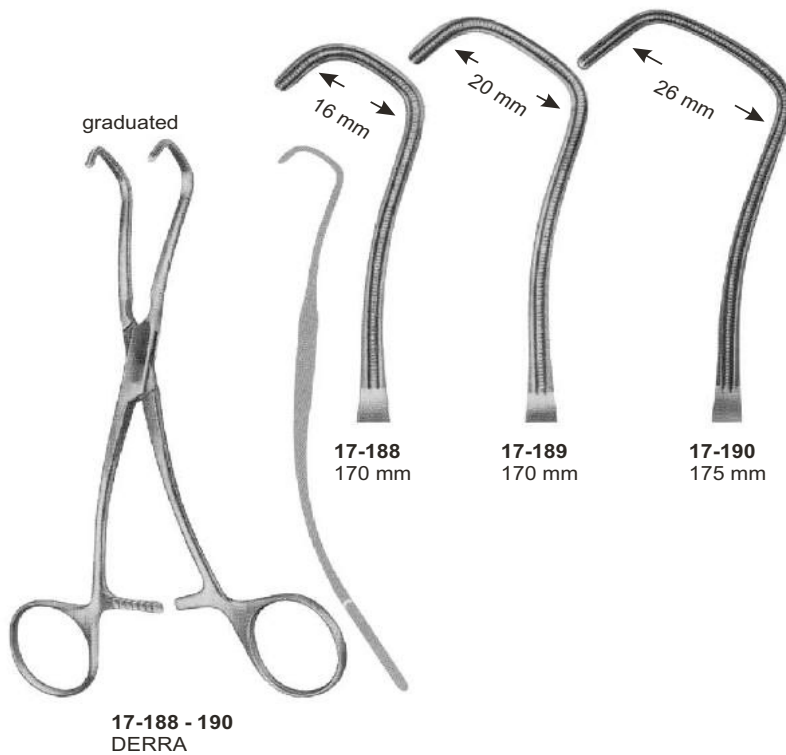
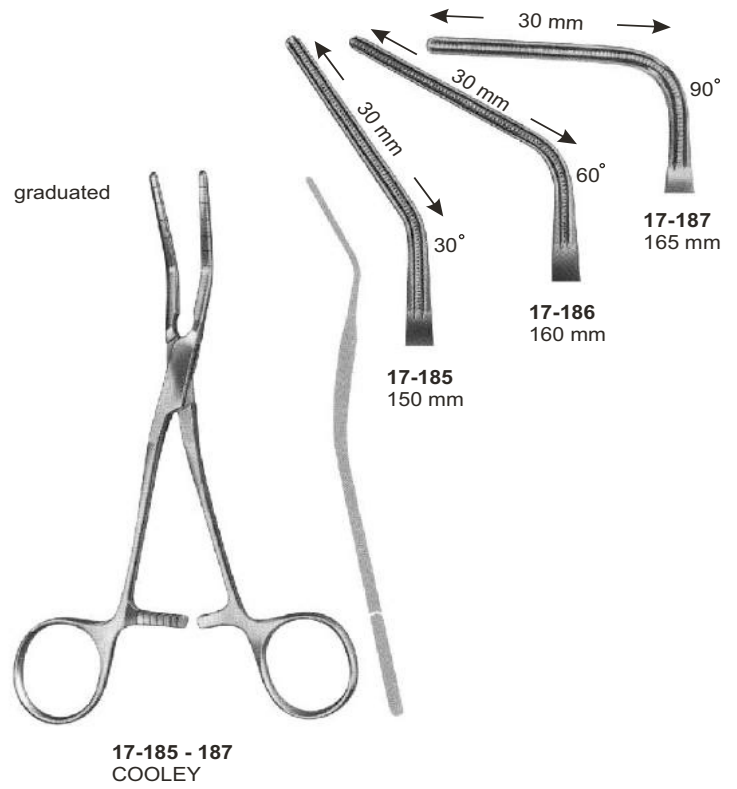
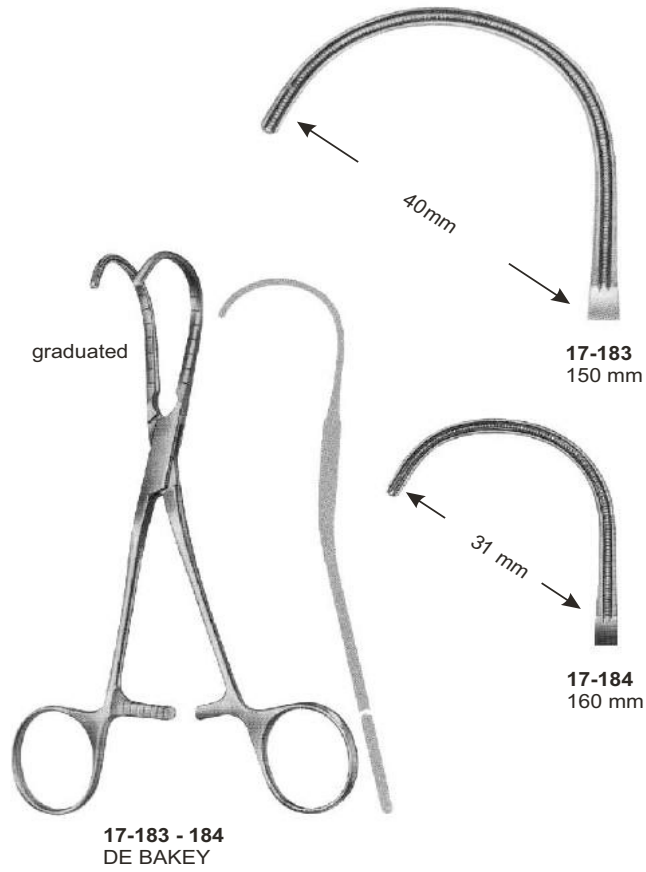

# Vena-Cava Clamps



**17-218**  
86 mm



**17-219**  
86 mm



**17-220**  
86 mm

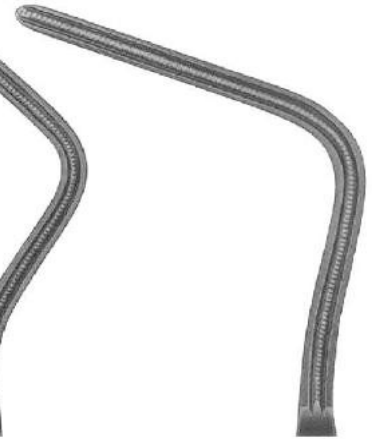

**17-221**  
86 mm

**17-218 - 221**  
DE BAKEY-HARKEN  
17-218 - 255 mm  
17-219 - 245 mm  
17-220 - 245 mm  
17-221 - 245 mm



**17-222 - 226**  
DE BAKEY

Total Length:

Length of jaws:



36 mm

**17-222**

220 mm

85 mm

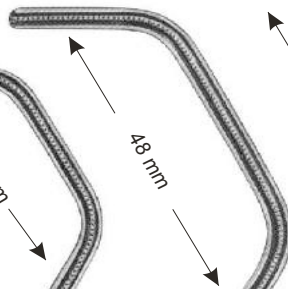

48 mm

**17-223**

256 mm

95 mm

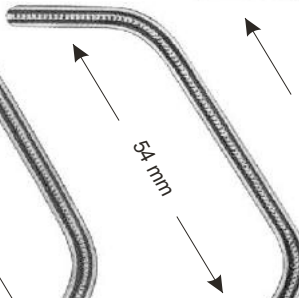

54 mm

**17-224**

270 mm

99 mm

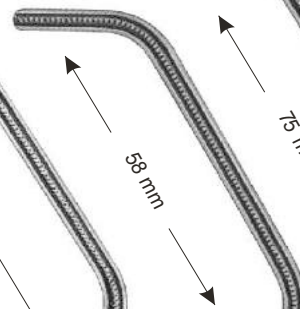

58 mm

**17-225**

270 mm

103 mm

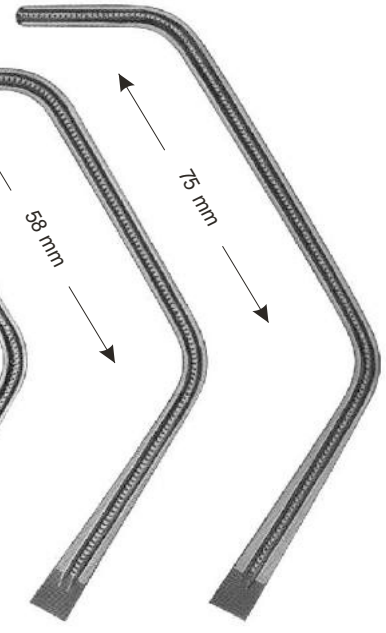

75 mm

**17-226**

280 mm

119 mm

# Rib Holding Forceps, Bone Cutting Forceps



**17-362**  
SEMB  
Rib-and Bone  
Holding forceps  
190 mm



**17-363**  
SEMB  
Rib-and Bone  
Holding forceps  
190 mm



**17-364**  
LISTON-STILLE  
265 mm

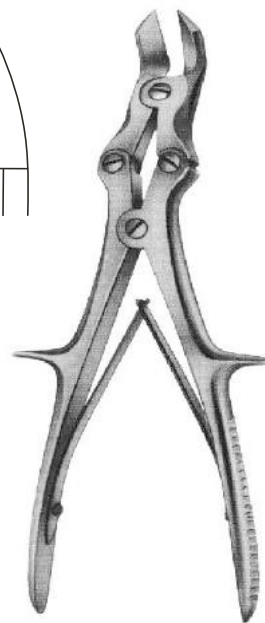
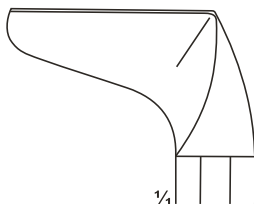

**17-365**  
LISTON-KEY-HORSLEY  
255 mm

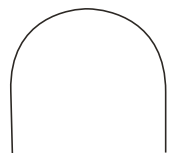
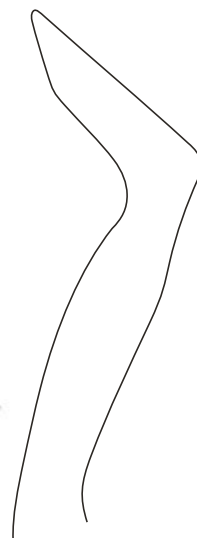

**17-367**

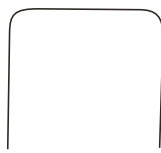

**17-368**

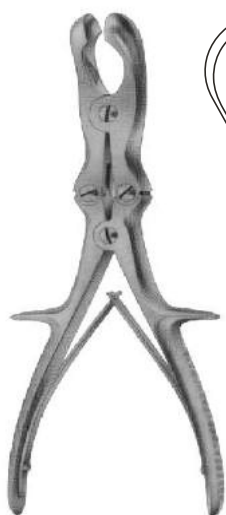

**17-366**  
SEME  
Rib Rongeur to shorten  
the rib stumps  
240 mm

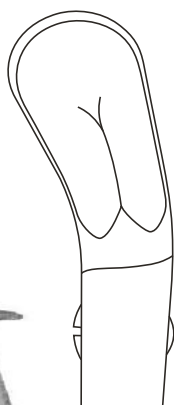

**17-367-368**  
SAUERDRUCH-CORYLLOS  
Rib rongeurs to shorten  
the rib stumps  
310 mm



**17-369**  
MARKWALDER  
Rib Rongeur to Round  
the rib stumps  
190 mm

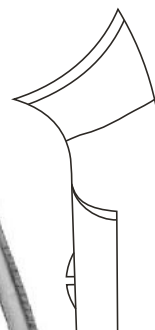



## Sternotomy- Spreaders

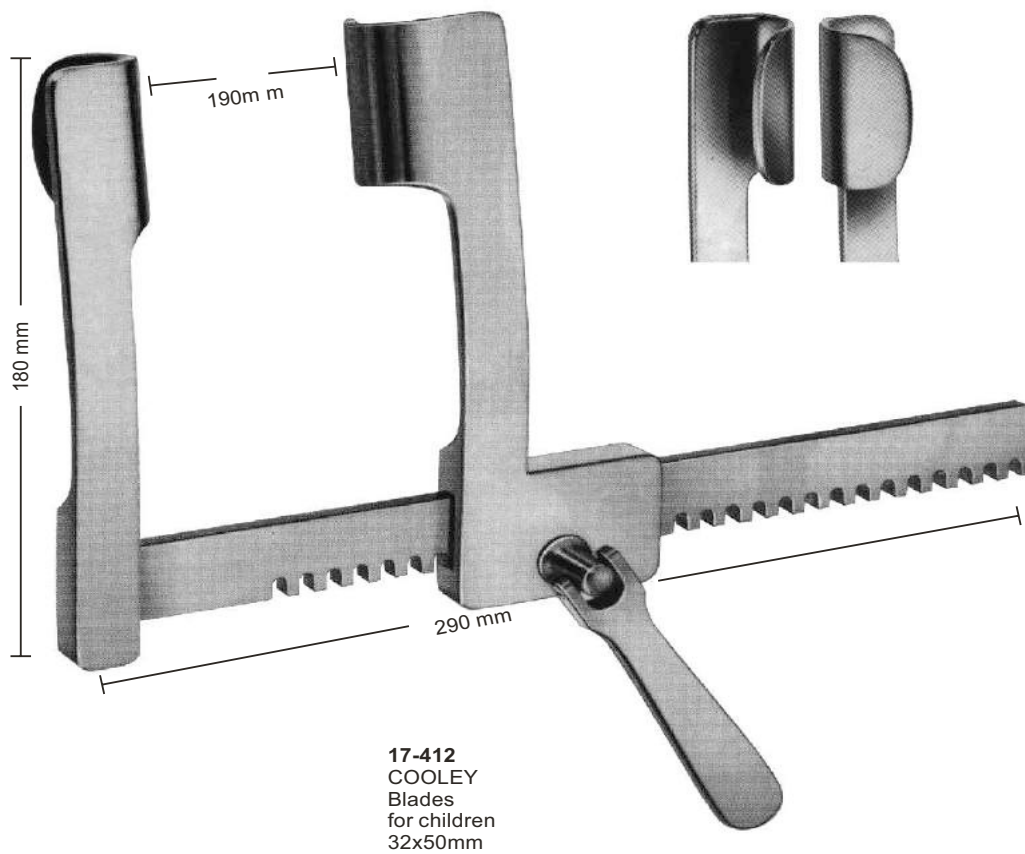
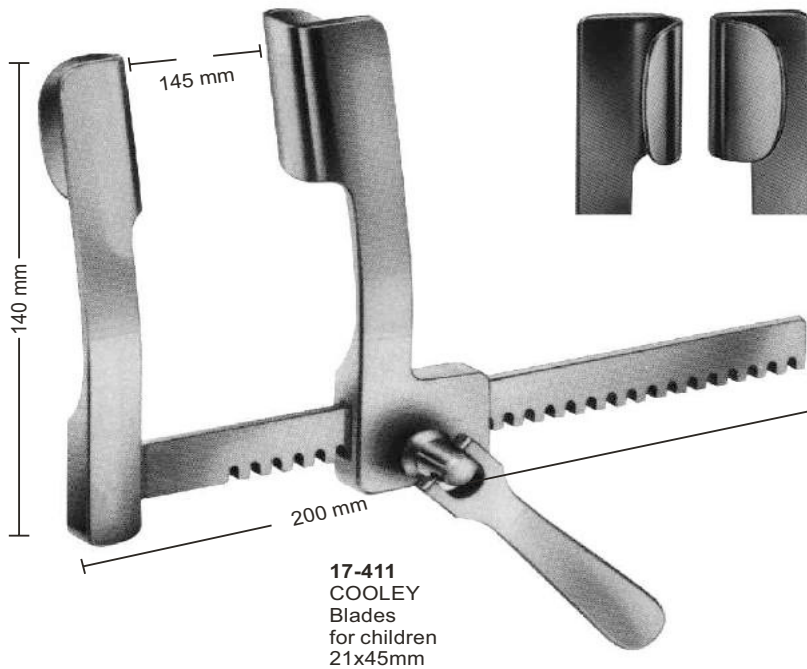

# Rongeurs

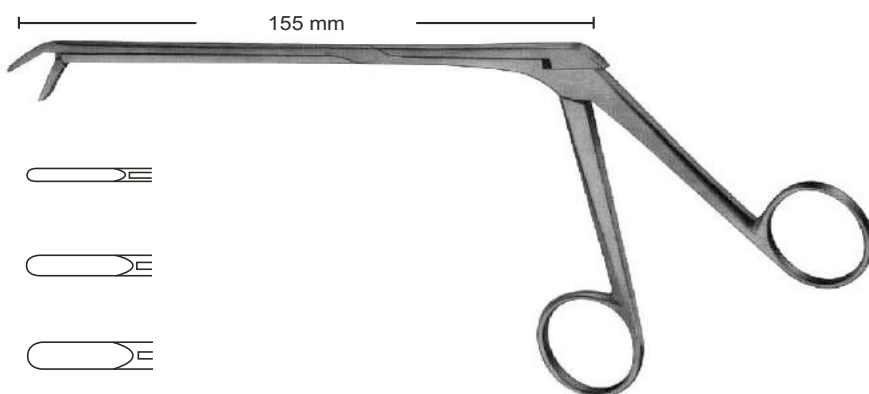

**18-135**  
2 mm

**18-136**  
3 mm

**18-137**  
4 mm

**18-135 - 137**  
CASPAR

Length of shaft 140 mm	Length of shaft 160 mm	Length of shaft 185 mm	size of jaws
<b>18-138</b>	<b>18-143</b>	<b>18-148</b>	2 X12 mm
<b>18-139</b>	<b>18-144</b>	<b>18-149</b>	3 X12 mm
<b>18-140</b>	<b>18-145</b>	<b>18-150</b>	4 X14 mm
<b>18-141</b>	<b>18-146</b>	<b>18-151</b>	5 X14 mm
<b>18-142</b>	<b>18-147</b>	<b>18-152</b>	6 X16 mm

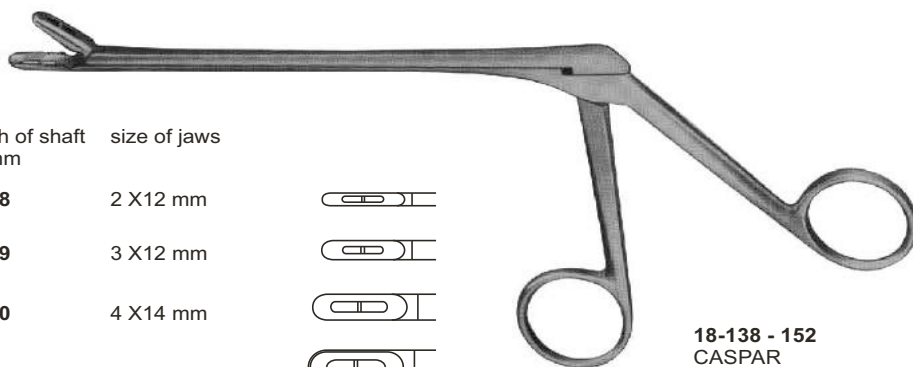

**18-138 - 152**  
CASPAR

Length of shaft 140 mm	Length of shaft 160 mm	Length of shaft 185 mm	size of jaws
<b>18-153</b>	<b>18-156</b>	<b>18-159</b>	3 X12 mm
<b>18-154</b>	<b>18-157</b>	<b>18-160</b>	4 X14 mm
<b>18-155</b>	<b>18-158</b>	<b>18-161</b>	5 X14 mm

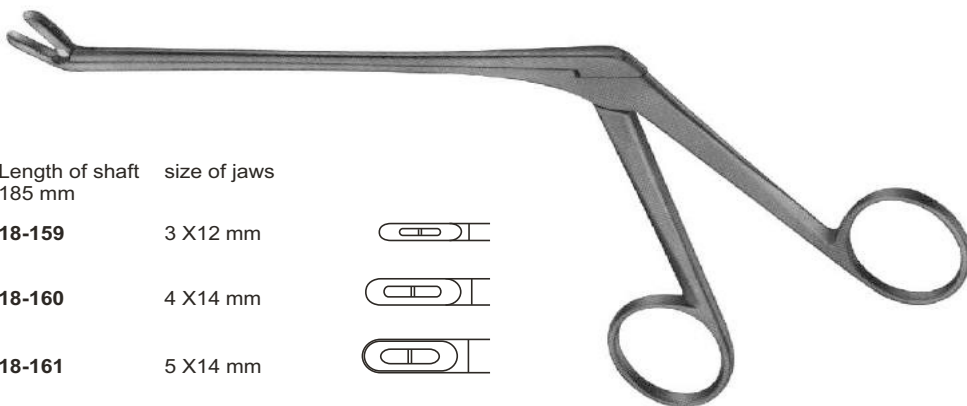

**18-153 - 161**  
CASPAR

## Mallets



Ø 20 mm

**21-101**  
MEAD  
185 g  
with interchangeable  
plastic disks  
190 mm  
**21-102**  
pair of spare disks



**21-103**  
140 g  
with interchangeable  
plastic disks  
185 mm  
**21-104**  
pair of spare disks



Ø 25 mm

**21-105**  
COTTLE  
140 g  
1 Seite convex  
1 Side convex  
185 mm



Ø 22 mm

**21-106**  
165 g  
lead filled head  
190 mm

# Reposition Forceps



**22-101**  
Reposition forceps,  
for small fragments  
135 mm



**HAASE**  
**22-102**  
Reposition forceps,  
for mandibular  
fractures  
165 mm

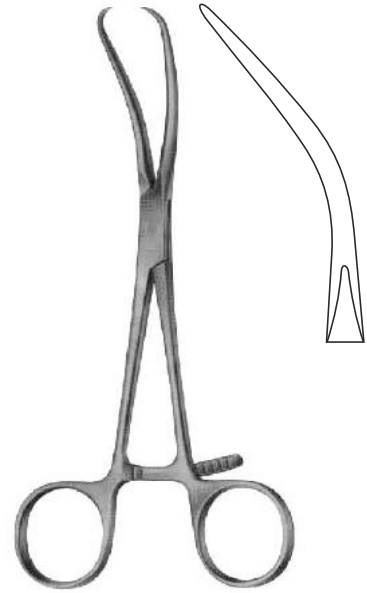

**REILL**  
**22-103**  
Reposition forceps,  
170 mm



**22-104**  
Reposition forceps  
205 mm

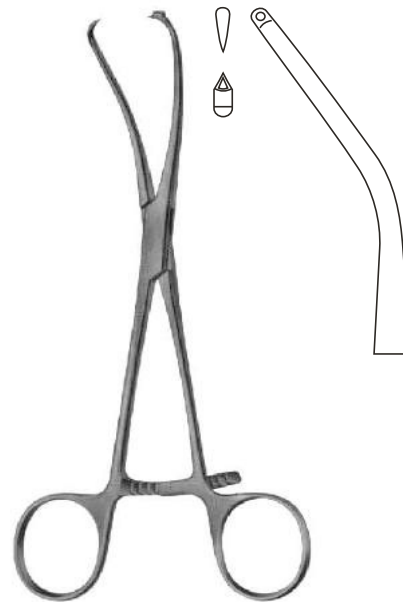

**MEYER**  
**22-105**  
Reposition forceps  
for fingers, with drill  
guide for KIRSCHNER  
wires up to diam. 1.0 mm  
170 mm

# Bone Holding Forceps



**22-124 - 128**

- 22-124** 145 mm
- 22-125** 190 mm
- 22-126** 240 mm
- 22-127** 260 mm
- 22-128** 280 mm

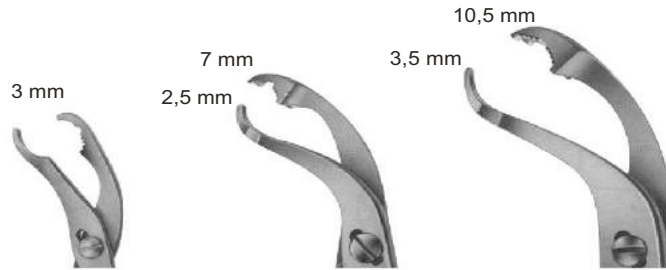

**22-124**  
for small  
fragments  
11 mm

**22-125**  
Fig: 0

**22-126**  
Fig: 1

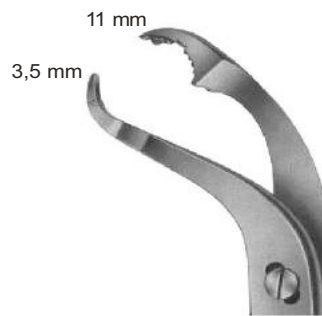

**22-127**  
Fig: 2



**22-128**  
Fig: 3

Self-centering forceps  
with thread fixation



**22-129 - 131**  
VERBRUGGE  
with lip joint

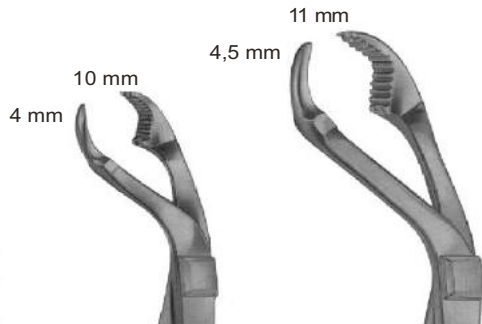

**22-129**  
Fig: 1

**22-130**  
Fig: 2

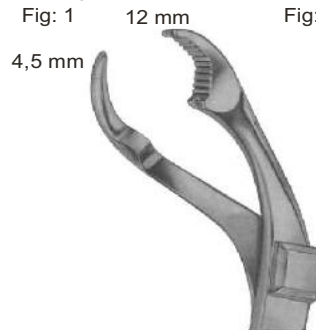

**22-131**  
Fig: 3



**22-132**  
LAMBOTTE  
265 mm

# Bone Rongeurs

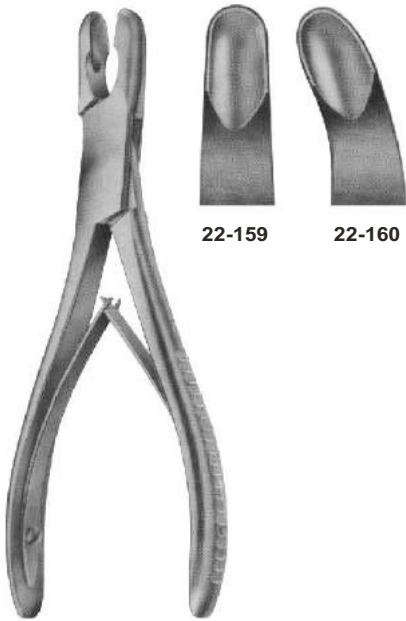

22-159

22-160

22-159 - 160  
LURE  
175 mm



22-161  
LURE  
180 mm



22-162  
LURE  
180 mm

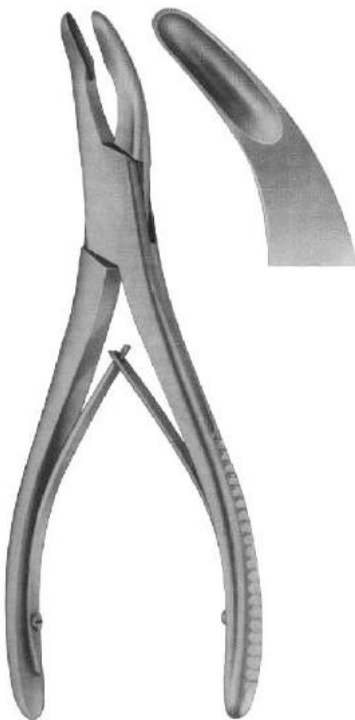

22-163  
OLIVECRONA  
205 mm



22-164

22-165

22-164 - 165  
BOHLER  
155 mm



22-166  
MARQUARTD  
200 mm

# Plaster Instruments



with ebony handle

**24-101**  
HOPKINS  
200 mm



**24-102**  
ESMARCH  
180 mm



**24-103**  
ENGEL  
160 mm

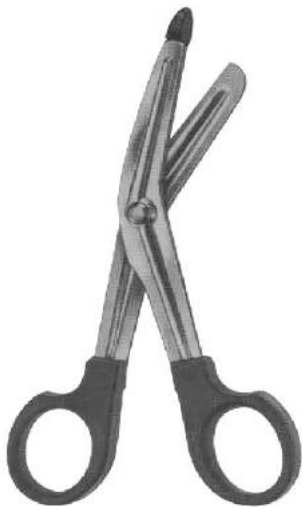

**24-104 - 112**

- |                     |                           |
|---------------------|---------------------------|
| <b>24-104</b> black | <b>24-108</b> yellow      |
| <b>24-105</b> red   | <b>24-109</b> white       |
| <b>24-106</b> blue  | <b>24-110</b> orange      |
| <b>24-107</b> green | <b>24-111</b> lavender    |
|                     | <b>24-112</b> bright pink |



**24-113 - 121**

- |                     |                           |
|---------------------|---------------------------|
| <b>24-113</b> black | <b>24-117</b> yellow      |
| <b>24-114</b> red   | <b>24-118</b> white       |
| <b>24-115</b> blue  | <b>24-119</b> orange      |
| <b>24-116</b> green | <b>24-120</b> lavender    |
|                     | <b>24-121</b> bright pink |

# Scissors with Tungsten Carbide Inserts



16cm

**26-107**  
Mayo-Lexer



16cm

**26-108**  
Mayo-Lexer



16cm  
21cm

**26-109**  
Lexer



16cm  
21cm

**26-110**  
Lexer



15cm  
17cm

**26-111**  
Mayo-Stille



15cm  
17cm

**26-112**  
Mayo-Stille



# Scissors with Tungsten Carbide Inserts

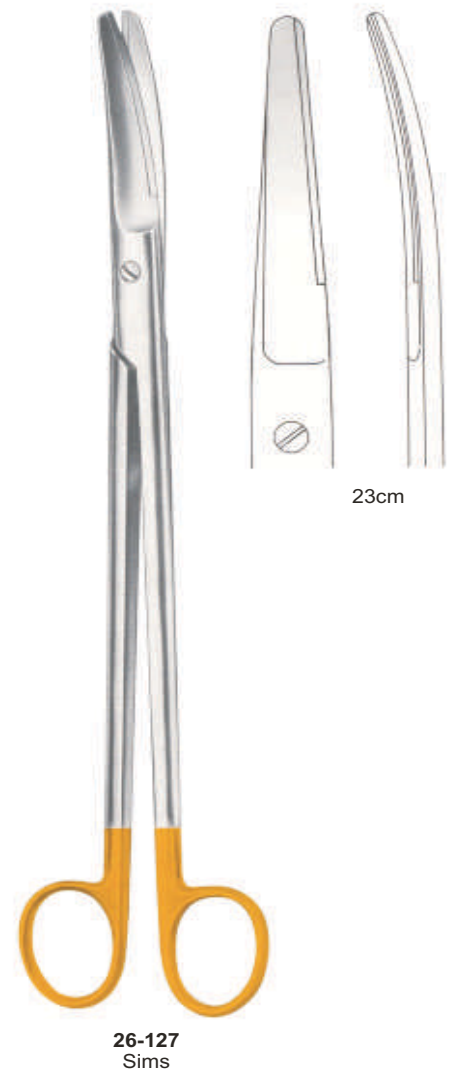

# Needle holders with Tungsten Carbide Inserts



**26-159**  
Bozemann-Wertheim  
20cm 24cm 26cm



**26-160**  
Stratte  
22cm 23cm

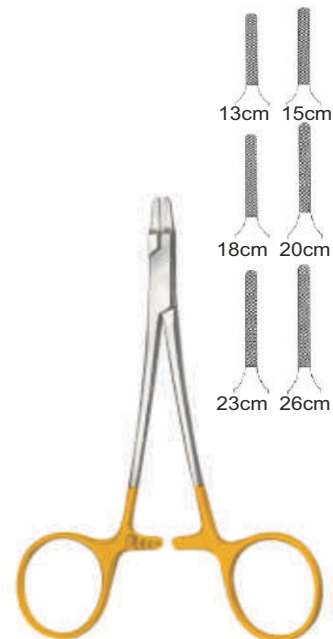

**26-161**  
Ryder  
13cm 15cm 18cm  
20cm 23cm 26cm



**26-162**  
Ryder-Vascular  
13cm 15cm 18cm  
20cm 23cm 26cm



**26-163**  
Martin  
15cm 17cm 20cm



**26-164**  
Sarot  
18cm 20cm 26cm

# Needle holders with Tungsten Carbide Inserts



**26-172**  
Mathieu-Ryder  
17cm  
20cm 24cm



**26-173**  
Lichtenberg  
20cm



**26-174**  
Langhals  
20cm 25cm



**26-175**  
Lichtenberg  
20cm 25cm



**26-176**  
Luehty-Beck  
20cm 25cm



**26-177**  
Luehty-Beck  
20cm 25cm



**26-178**  
Langebeck  
18cm  
20cm 23cm



**26-179**  
Langebeck-beck  
18cm  
20cm 23cm

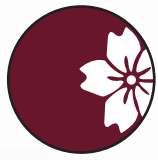

# Sakura International

Manufacturer & Exporter of Surgical Instruments

Muslim Colony, Sharif Park Haji, Sialkot 51310 Pakistan

 +92-300-6152628 Tel: +92-52-3259003

E-mail: sakura.pk12@gmail.com

